

**STUDY OF THE SKINCALM® FILLING PROCESS AT ASPEN  
PHARMACARE  
APPLYING SOME SIX SIGMA PRINCIPLES**

by

**Johannes Marx**

Baccalaureus Scientiae, Baccalaureus Pharmaciae,  
University of Port Elizabeth

A dissertation submitted for the partial fulfilment  
of the requirements for the

**Magister Technologiae: Chemistry (Product and Process Development)**

In the Faculty of Science at the

NELSON MANDELA METROPOLITAN UNIVERSITY

**Date of Submission**

**January 2005**

**03 January 2005**

**Promoter:**

**Prof. B.Zeelie**

**TO WHOM IT MAY CONCERN**

**RE: CONFIDENTIALITY CLAUSE**

This work is of strategic importance.

It would be appreciated if the contents of this dissertation remain confidential and not be circulated for a period of five years.

Sincerely,

J.Marx

## **ACKNOWLEDGMENTS**

- My promoter (Prof. B. Zeelie) and Aspen Pharmacare Project Mentor (Mr. S. Dana) for their help and guidance.
- The staff of Aspen Pharmacare for their advice and assistance.
- My wife and parents for their support and encouragement.

# TABLE OF CONTENTS

<b>ACKNOWLEDGEMENTS.....</b>	<b>I</b>
<b>TABLE OF CONTENTS.....</b>	<b>II</b>

## PART A: TECHNOLOGY DESCRIPTION

<b>EXECUTIVE SUMMARY.....</b>	<b>V</b>
-------------------------------	----------

### CHAPTER 1

<b>INTRODUCTION.....</b>	<b>1</b>
<b>1.1. ASPEN PHARMACARE.....</b>	<b>1</b>
<b>1.2. WHAT IS SIX SIGMA?.....</b>	<b>2</b>
<b>1.3. SIX SIGMA VERSUS THREE SIGMA.....</b>	<b>5</b>
<b>1.4. THE HISTORY OF SIX SIGMA.....</b>	<b>6</b>
<b>1.5. THE EVOLUTION OF SIX SIGMA.....</b>	<b>8</b>
<b>1.6. KEY ELEMENTS OF SIX SIGMA.....</b>	<b>10</b>
<b>1.6.1. THE CUSTOMER.....</b>	<b>10</b>
<b>1.6.2. THE PROCESS.....</b>	<b>10</b>
<b>1.6.3. THE EMPLOYEE.....</b>	<b>10</b>
<b>1.7. CUSTOMER AND MARKET DRIVEN ENTERPRISE.....</b>	<b>11</b>
<b>1.7.1. ELEMENTS OF THE TRANSFORMED ORGANISATION....</b>	<b>11</b>
<b>1.8. ASPEN'S COMMITMENT TO CHANGE.....</b>	<b>12</b>

<b>1.9. SCOPE OF PROJECT.....</b>	<b>13</b>
-----------------------------------	-----------

## **CHAPTER 2**

<b>USE OF SIX SIGMA PRINCIPLES IN THE OINTMENTS AND CREAMS FILLING OPERATION.....</b>	<b>14</b>
---	-----------

<b>2.1. STEP 1: DEFINE OPERATION.....</b>	<b>14</b>
<b>2.1.1. MACRO VALUE STREAM.....</b>	<b>14</b>
<b>2.1.2. PROCESS FLOW DIAGRAM.....</b>	<b>17</b>
<b>2.1.3. INPUT PROCESS OUTPUT (IPO).....</b>	<b>20</b>
<b>2.2. STEP 2: MEASURE.....</b>	<b>23</b>
<b>2.2.1. CAUSE AND EFFECT DIAGRAM.....</b>	<b>23</b>
<b>2.2.2. THE 5S PHILOSOPHY.....</b>	<b>33</b>
<b>2.2.3. MEASUREMENT SYSTEM ANALYSIS (MSA).....</b>	<b>39</b>
<b>2.2.3.1. Introduction.....</b>	<b>39</b>
<b>2.2.3.2. Measurement Study.....</b>	<b>39</b>
<b>2.2.4. PROCESS CHARACTERISATION.....</b>	<b>53</b>
<b>2.3. STEP 3: OPERATIONAL ANALYSES.....</b>	<b>60</b>
<b>2.3.1. PROCESS OPTIMISATION.....</b>	<b>60</b>
<b>2.3.1.1. Procedure for Tonazzi Set up, Sampling and Testing for         Variable Interactions in Filling Room.....</b>	<b>62</b>

## **CHAPTER 3**

<b>CONCLUSION AND RECOMMENDATIONS.....</b>	<b>83</b>
--	-----------

**BIBLIOGRAPHY.....85**

**PART B: FINANCIAL REPORT ON STUDY**

**FINANCIAL EXECUTIVE SUMMARY.....i**

**A. INTRODUCTION.....ii**

**B. COST ELEMENTS (METRICS)..... iv**

**C. FINDINGS.....ix**

**D. DISCUSSION.....xii**

**E. CONCLUSION.....xiv**

# CHAPTER 1

## INTRODUCTION

### 1.1. ASPEN PHARMACARE

Aspen Pharmacare is listed on the Johannesburg Securities Exchange South Africa (JSE) and is Africa's largest pharmaceutical manufacturer. The company is a major supplier of branded pharmaceutical and healthcare products to the local and selected international markets. For decades, Aspen has manufactured a basket of affordable, quality, and effective products for the ethical, generic over-the-counter (OTC) and personal care markets. Aspen is also the leading supplier of generic medicines to the public sector, providing comprehensive coverage of the products on the Essential Drug List.

Aspen continues to deliver on its commitment toward playing a role in social responsibility diseases such as HIV/AIDS, tuberculosis and malaria. In August 2003 Aspen developed Africa's first generic anti-retroviral drug, namely Aspen-Stavudine. Aspen's manufacturing facilities are based in Port Elizabeth (PE) and East London. Aspen has recently completed an Oral Solid Dosage (OSD) manufacturing facility worth approximately R150 million in PE. The Group manufactures approximately 20 tons of product daily and in excess of 400 tons of solid dosage pharmaceuticals, which equates to more than 2 billion tablets. In addition, more than 3 million litres of liquid pharmaceuticals and over 200 tons of pharmaceutical creams and ointments are produced per year [1].

Aspen excels at delivering quality products and services, exceeding customer expectations, complying with international standards in an environment that cultivates technical expertise and innovation. Following this philosophy through to the shop floor areas mean that there are always initiatives in continuous production improvement. One of these improvement projects introduced is called Six Sigma.

Ten members of the staff, selected from different expertise fields in the company were trained in Six Sigma. Knowledge gained from the two week training course were applied to different areas in the factory using Six Sigma principles.

This dissertation focuses on the study undertaken in one of production areas, namely the filling process of the ointments and creams at the Aspen Port Elizabeth facility.

## **1.2. WHAT IS SIX SIGMA?**

First, what it is not. It is not a secret society, a slogan or a cliché. Six Sigma ( $6\sigma$ ) is a financially disciplined process that helps industry focus on developing and delivering near-perfect products and services by using a disciplined, structured approach. Six Sigma began in the 1980's at Motorola® [2] and can be described as a management philosophy to make an organisation more effective and efficient [3]. While Six Sigma at many organisations simply means a measure of quality, it represents a major deviation away from “quality inspection” to “quality improvement”. It is a disciplined, data driven approach and methodology for eliminating defects (driving towards the goal of six standard deviations between the mean and the nearest specification limit) in any process [4].

Effectiveness is the degree to which an organisation meets and exceeds the needs and requirements of its customers and stakeholders. Efficiency is the resources consumed in achieving effectiveness [5], and includes issues such as time, cost, labour, raw material, etc.

Six sigma guides companies into making fewer mistakes in what they do [6] and its basis is measuring process performance in terms of defects. When operating at the Six Sigma standard, a process is delivering only 3.4 defects per million opportunities (DPMO). DPMO can be defined as the average number of defects per unit observed during an average production run divided by the number of opportunities to make a defect on the product under study during that run normalised to one million [4]. Six



Sigma is a high performance, data driven approach that analyses the root cause of business problems with the view to solve them. It directly ties the outputs of a business to marketplace requirements [7].

Sigma (the Greek letter  $\sigma$ ) is a statistical term that measures standard deviation (a measure of the spread of data points in relation to the mean). In the context of management, it is used to measure defects in the outputs of a process and show how far the process deviates from perfection. A defect can be defined as a measurable characteristic of the process, or its output, that is not within the acceptable customer limits, i.e., not conforming to specifications. The sigma level of a process is calculated in terms of DPMO.

A process operating at one-sigma (i.e. only one standard deviation between the mean and the standard specification) produces 691462.5 defects per million opportunities, which translates to a satisfactory output percentage (%) of only 30.854%. This is considered really poor performance. If a process functions at the three sigma level, the process is producing 66807.2 errors per million opportunities, delivering 93.319% satisfactory outputs. Table 1.1 summarises the amounts of DPMO at different sigma levels [8]. Any DPMO is money that is being wasted and is therefore unacceptable to customers and shareholders.

Most organisations in the United States are operating at three to four sigma quality levels. This means they could be losing up to 25% of their total revenue due to processes that deliver too many defects. These defects take up time and effort to repair as well as make customers unhappy [8].

Capability Index	Defects per million opportunities	Percent of output defect free
6 sigma	3.4	99.99966%
5.5 sigma	32	99.9968%
5 sigma	230	99.97%
4.5 sigma	1350	99.865%
4 sigma	6210	99.4%
3.5 sigma	22800	97.72%
3 sigma	66800	93.3%
2.5 sigma	159000	84.1%
2 sigma	308000	69.2%
1.5 sigma	500000	50%
1 sigma	690000	31%
0.5 sigma	841000	16%

**TABLE 1.1 DPMO AT VARIOUS SIGMA LEVELS**

At the operational or process level, Six Sigma's goal is to move business, product, or service attributes to within the zone of customer acceptance and to dramatically shrink process variation, the cause of defects that negatively affect customers [7].

Companies that implement Six Sigma do so with the goal of improving their margins. Prior to Six Sigma, improvements brought about by quality programs usually had no visible impact on a company's net income. Organisations that cannot track the effect of quality improvements on profitability do not know what changes need to be made to improve their profit margins [6].

### 1.3. SIX SIGMA VERSUS THREE SIGMA

The traditional quality model of process capability differed from Six Sigma in two fundamental respects [6]:

- (a) It was applied only to manufacturing processes, while Six Sigma is being applied to all important business processes.
- (b) It stipulated that a capable process was one that had a process standard deviation (measure of variability in a data set or in a population) of no more than one-sixth of the total allowable spread, whereas Six Sigma requires the process standard deviation be no more than one-twelfth of the total allowable spread.

These differences are profoundly different. By addressing all business processes, Six Sigma not only treats manufacturing as part of a larger system, it also removes the narrow, inward focus of the traditional approach. Customers care more than just how well a product is manufactured. Price, service, financing terms, style, availability, frequency of updates and enhancements, and a host of other items are also important. When operations become more cost-effective and the product design cycle shortens, owners or investors benefit as well. When employees become more productive, their pay can be increased. Six Sigma's broad scope means that it provides benefits to all stakeholders in an organisation.

Six Sigma is a process quality goal, where sigma is a statistical measure of variability (property of exhibiting variation, i.e. changes or differences) in a process (see section 1.2). As such, Six Sigma falls into the category of a process capability technique. The traditional quality paradigm defined a process as capable if the process's natural spread, plus or minus Three Sigma ( $3\sigma$ ), was less than the engineering tolerance (the permissible range of variation in a particular dimension of a product). Under the assumption of normality, this  $3\sigma$  quality level translates to a process yield of 99.73%. A later refinement considered the process location as well as its spread, and

tightened the minimum acceptance criterion so that the process mean was at least Four Sigma ( $4\sigma$ ) from the nearest engineering requirement. Six Sigma requires that processes operate such that the nearest engineering requirement is at least Six Sigma from the process mean.

Six Sigma also applies to attribute data, such as counts of things gone wrong. This is accomplished by converting the Six Sigma requirements to equivalent conformance levels.

A process operating at Six Sigma will produce 3.4 parts per million (ppm) non-conformances. In contrast, the  $3\sigma$  quality standard of 99.73% translates to 2700 ppm failures. For processes with a series of steps, the overall yield is the product of the yields of the different steps. Note that the overall yield from processes involving a series of steps is always less than the yield of the step with the lowest yield. If  $3\sigma$  quality levels (99.97% yield) are obtained for every step in a ten step process, the quality level at the end of the process will contain 26674 defects per million! Considering that the complexity of modern processes is usually far greater than ten steps, it is easy to see that Six Sigma quality is not optional; it's required if an organisation is to remain viable [9].

#### **1.4. THE HISTORY OF SIX SIGMA**

Six Sigma can be traced back to Carl Federal Gauss (1777) who introduced the concept of a normal curve. Sigma representing deviation is traced back to 1920's when Walter Stewart showed sigma from the mean is the part where a process required correction [10].

Six Sigma started as a process improvement methodology to improve the quality at Motorola® in the 1980's [8]. According to the Motorola® University's course, the following six steps are needed to accomplish Six Sigma results:

- Identify the product produced or the service provided.
- Identify the need to satisfy your customer.

- Identify what is required to provide the product produced or service that satisfy the customer.
- Define the process for doing the work.
- Mistake proof the process and eliminate wasted effort.
- Ensure continuous improvement by measuring, analysing, and controlling the improved process.

The success of Six Sigma at Motorola® led to programs in the 1990's at Allied Signal® and the highly publicised implementation of Six Sigma at General Electric®. The success of the Six Sigma program at General Electric® is based on a five step process:

1. Define.
2. Measure.
3. Analyse.
4. Improve.
5. Control.

The five step approach gained a lot of attention under the leadership of Jack Welch at General Electric® and is the subject of numerous books and studies on process improvement [11].

## 1.5. THE EVOLUTION OF SIX SIGMA

Process capability, called  $C_P$ , is defined as S/P for a given parameter, where:

S= the specification width (highest minus the lowest allowable reading)

P= the process width (highest minus the lowest observed reading)

$C_P$  is thus a measure of the ability of a process to produce consistent results, the ratio between the permissible spread and the actual spread of a process as defined above [4].  $C_{PK}$  is process capability (proportion of natural tolerance between the center of the process and the nearest specification), corrected for a noncentering of the process average,  $\bar{X}$ , relative to the design center (or target value). If  $\bar{X}$  and the design center are the same,  $C_{PK} = C_P$ ; if not, a slight formula correction lowers  $C_{PK}$  relative to  $C_P$ . Traditionally, process width is also measured in sigma terms, where sigma (Greek letter  $\sigma$ ) is the standard deviation of a group of data, for a given parameter, from its average  $\bar{X}$ . Sigma level can be defined as the number of standard deviations between the center of the process and the nearest specification.

- Until the 1970's, a process width of  $\bar{X} \pm 3 \sigma$  (natural tolerance) was larger than a specification width of  $\bar{X} \pm 2 \sigma$ . This resulted in a defect level of 4.5 %, but was considered "good enough" quality. This meant a resulting  $C_{PK}$  value of 0.67.
- In the 1980's, process widths were targeted to equal specification widths, with both at  $\bar{X} \pm 3 \sigma$ . This resulted in a lower level of 0.27 % or 2700 parts per million (ppm) and was considered a "real out" quality level, with a  $C_{PK}$  of 1.0.
- In the 1990's, with global competition driving quality toward zero defects, process limits at  $\bar{X} \pm 3 \sigma$ , and specification limits  $\bar{X} \pm 3 \sigma$  (i.e. a  $C_{PK}$  of 1.33), the defect level is further reduced to 63 ppm.
- In the 2000's, world-class companies are striving for process widths reduced to  $\bar{X} \pm 3 \sigma$ , relative to specification limits of  $\bar{X} \pm 5 \sigma$ , resulting in defect levels as low as 0.57 ppm (i.e. a  $C_{PK}$  of 1.67).

The Six Sigma quality program by Motorola® stresses the use of measures like  $C_{PK}$ ,  $C_P$ , and defects per million (dpm) to indicate how good a product or process is. Motorola® strives to reduce process width's to  $\bar{X} \pm 3 \sigma$ , relative to specification width limits of  $\bar{X} \pm 6 \sigma$ , lowering the defect level to a microscopic two parts per billion (ppb), or a  $C_{PK}$  of 2.0. For all practical purposes, that is *zero defects*. This is the statistical meaning of Six Sigma.

As defined by Motorola®, the term “6  $\sigma$  quality” means:

- $C_P = 2.0$
- $C_{PK} = 1.5$
- $Dpm = 3.4$

Motorola® assumes that a process average may shift and drift  $1.5 \sigma$  without detection [12]. Table 1.2 depicts these relationships [13].

Specification Width	Amount Defective Outside Specification Width		
	Percentage (%)	PPM/PPB	$C_{PK}$
$\bar{X} \pm 2 \sigma$	4.56	45600 ppm	0.67
$\bar{X} \pm 3 \sigma$	0.27	2700 ppm	1.00
$\bar{X} \pm 4 \sigma$	0.0063	63 ppm	1.33
$\bar{X} \pm 5 \sigma$	0.00057	0.57 ppm	1.67
$\bar{X} \pm 6 \sigma$	0.000002	0.02 ppm (2ppb)	2.00

**TABLE 1.2 RELATIONSHIP BETWEEN SPECIFICATION WIDTH AND DEFECTS OUTSIDE SPECIFICATION WIDTH**

## **1.6. KEY ELEMENTS OF SIX SIGMA**

There are three key elements of quality, the customer, the process and the employee. In everything a world-class quality company does, its focus must be on these three essential elements.

### **1.6.1. THE CUSTOMER**

Customers define ultimate quality. Companies must be guided by the voice of their customers [14]. They expect performance, reliability, competitive prices, on-time delivery, service, clear and correct transaction processing and more. In every aspect that influences customer perception, just being good is not enough. Delighting the customers is an absolute necessity.

### **1.6.2. THE PROCESS**

Quality requires companies to look at their business from the customer's perspective, not theirs. In other words, companies must look at their processes from the outside in. With this knowledge, areas can be identified where significant value can be added or improvement actions can be taken. Quality is perceived as the primary driver in the effort to get new customers and keep existing customers.

### **1.6.3. THE EMPLOYEE**

People create results, and involving all employees in quality improvement is essential. The employees must focus their talents and energies on satisfying the customers, and in order to achieve successful results every employee must be involved, motivated and knowledgeable.

An organisation must thus be customer driven. This perspective is precisely the opposite of the traditional view of the organisation [9].



## **1.7. CUSTOMER AND MARKET DRIVEN ENTERPRISE**

A customer and market driven enterprise can be defined as one that is committed to provide excellent quality and competitive products and services to satisfy the needs and wants of a well-defined market segment [9]. The journey from traditional to a customer driven organisation has been made by organisations to allow identification of a number of distinct milestones that mark the path to success. Generally, the journey begins with recognition that a crisis is either upon the organisation, or imminent.

### **1.7.1. ELEMENTS OF THE TRANSFORMED ORGANISATION**

Customer-driven organisations share certain common features [9].

- Flattened hierarchies – getting everyone closer to the customer involves reducing the number of bureaucratic “layers” in the organisational structure. The customer comes first, not the boss. Everyone serves the customer.
- Risk-taking – customer demands tend to be unpredictable. Responsiveness requires that organisations be willing to change quickly, which involves uncertainty and risk. Customer-driven organisations encourage risk-taking in a variety of ways. One important aspect is to celebrate mistakes made by individuals who engage in risky behaviour. Employees are encouraged to act on their own best judgements and not to rely on formal approval mechanisms.
- Communication – during the transformation, the primary task of the leadership team is the clear, consistent, and unambiguous transmission of their vision to others in the organisation.
- Unions – in the transformed organisation, everyone’s job changes. If the organisation’s employees are unionised, changing jobs requires that the union becomes management’s partner in the transformation process. In the flat organisation, union employees will have greater authority. Union

representation should be involved in all phases of the transformation, including planning and strategy development.

- Measuring results – it is important that the right things be measured. The “right things” are measurements that determine whether the organisation is delivering on its promises to customers, investors, employees, and other stakeholders. Measurements must be made for the right reasons. This means that measurements are used to learn about how to improve, not for judgement. Finally, measurements must be made the right way. Measurements should cover processes as well as outcomes. Data must be available quickly to the people who use them. Measurements must also be easy to understand.
- Rewarding employees – care must be taken to avoid rewarding with rewards. Rewarding individuals with financial incentives for simply doing their jobs well implies that employees would not do the job without reward. Rewards should not be used as a control mechanism. Employees should be provided with an adequate and fair compensation for doing their jobs [9].

## **1.8. ASPEN'S COMMITMENT TO CHANGE**

Globalisation and instant access to information, products and services have changed the way Aspen's customers conduct business – old business models are no longer adequate. Today's competitive environment leaves no room for error. To stay a market leader in the pharmaceutical industry in South Africa, Aspen is always striving to continuously improve production processes. For this reason, it is therefore a natural progression that the company embarked on the Six Sigma journey, among with other improvement projects. Aspen continuously strive to excel in delivering quality products and services which exceed customer expectations.

## **1.9. SCOPE OF PROJECT**

The focus of this particular Six Sigma project was to reduce or eliminate downtime and lead time in the ointments and creams packing group. Ointments and creams are characterised by a product range of relatively low volumes, but of high variety. Since unit production costs are high, a flexible but complex scheduling system, able to anticipate changing capacity and demand to match customer needs, is required.

The elimination of downtime and rework of products will improve lead times, improve supply capability, and realise a significant capacity improvement in utilisation, which in turn will reduce overhead costs.

The steps involved in this project were firstly to identify the key steps within the ointment and cream filling operation (step 1: define) to be able to define the overall process. Once the steps were identified, data about the operation (step 2: measure) was collected, to understand and learn about the operation. After all the data was collected, the data for a specific product (Skincalm® cream) was targeted for analyses and improvement, (step 3: analyse). This product was considered due to high customer demand.

The expected outcome of this study is to provide the information needed to make informed decisions with respect to the process.

## **CHAPTER 2**

### **USE OF SIX SIGMA PRINCIPLES IN THE OINTMENTS AND CREAMS FILLING OPERATION**

#### **2.1. STEP 1: DEFINE OPERATION**

##### **2.1.1. MACRO VALUE STREAM**

A macro value stream diagram or map provides a bird's eye overview of an entire business line such as the ointments and creams packing process. Such a value stream map provides a pictorial representation of how market expectations are connected to the business process to add value to the business operation. The macro value stream cuts across departmental, business, and/or divisional boundaries [15].

From Figure 2.1 it can be seen that that there are two types of stakeholders or customers in the ointments and creams packing process business, namely external and internal stakeholders or customers. External suppliers provide raw materials e.g. actives and packaging materials, to the factory. Raw materials are dispensed on a first in first out (FIFO) basis and moved to the manufacturing department. The manufacturing department converts the raw material to bulk product, which is moved to the filling and packing operation. Components and labels are issued directly from the component stores to the filling and packing operation. After filling and packing, the finished packs are analysed by the Quality Control Department (QC) and the Quality Assurance Department (QA) before final release and shipping to Tibbett and Britten (logistic company), who distributes the products to the market from their warehouses.

The entire ointments and creams packing process business line is controlled through the production control operation by means of various electronic and paper based

mechanisms. This production control operation is the link to the marketing operation, which in turn act on customer demand for the products.

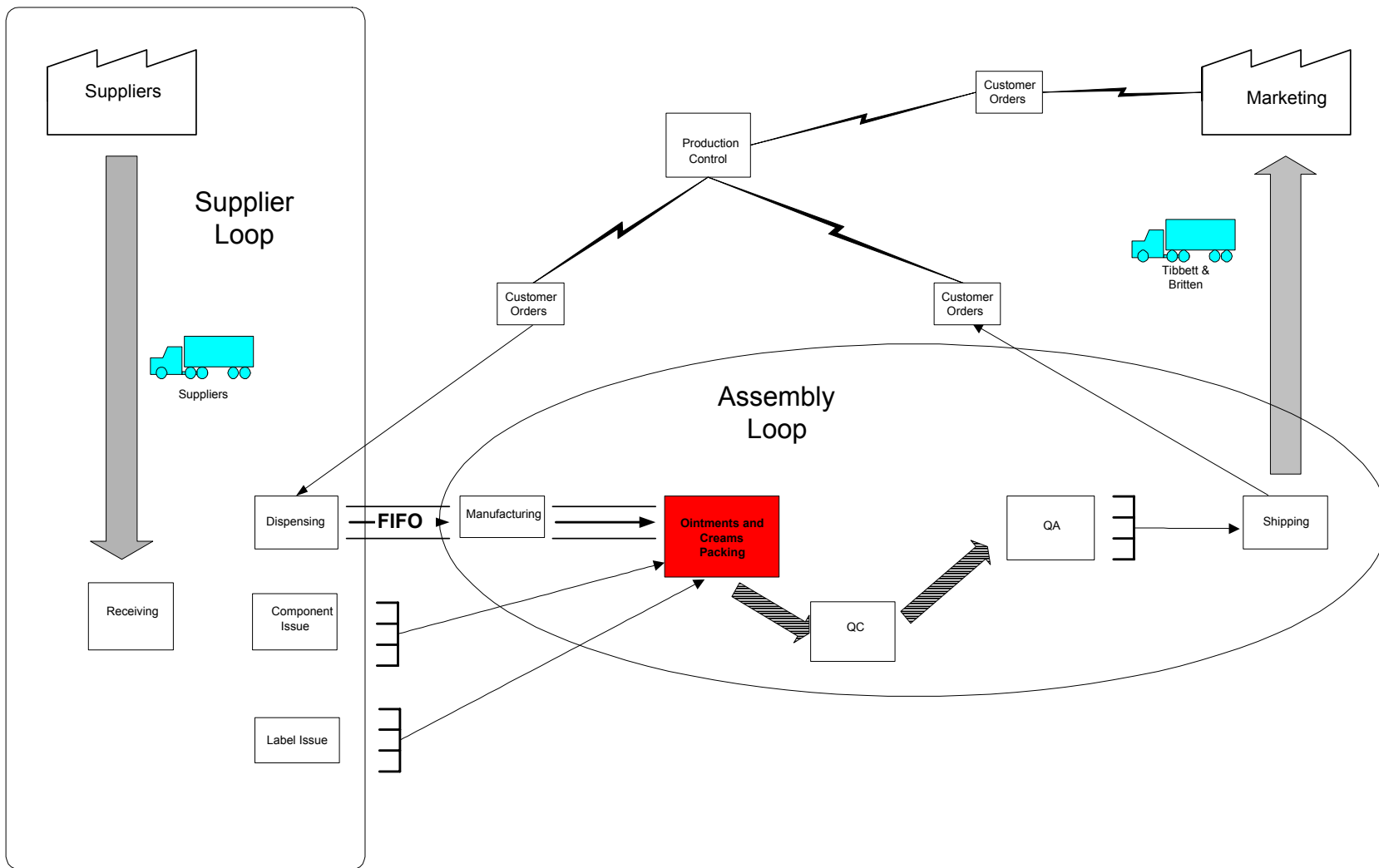

**FIGURE 2.2 MACRO PROCESS FLOW OF OINTMENTS AND CREAMS**

### **2.1.2. PROCESS FLOW DIAGRAM**

Before collecting data, it is important to understand the actual process in detail. Deciding when and where to collect data can be as important as the data itself, and the process flow diagram aids in defining the system or process under consideration. A process flow diagram is also a visual presentation of all the major steps in a process or part of a process, e.g. the ointments and creams packing process. Such diagrams not only promote the understanding of a process, but also provide a valuable tool for training employees since the visual outlay of the sequence of process steps can be very helpful in training employees to perform the process according to standardised procedures.

The process flow diagram for the filling and packing operation is illustrated in Figure 2.2. Before the filling operation can begin, the filling machine must be set up correctly and items need to be gathered and available in the filling room. In addition, regulatory required administration tasks need to be completed. (These pre-requirements are indicated by purple blocks in Figure 2.2):

- The bulk product.
- Administration (admin) duties – computer entries and documentation.
- Sanitising agents for the room.
- Personal protective equipment (PPE) including gowns.
- Microbial Laboratory (Micro Lab) swabs and plates.
- Components.

After the filling machine has been set up, the room is cleaned and sanitised. Pharmaceutical control checks are then made and clearance given for the filling operation to commence. After filling, the process can flow two ways. The filled tubes can either be directly transported on belts to an automatic (auto) cartner and shrink wrapping machine located in an adjacent room linked with a conveyor belt with the filling room, or the filled tubes can be packed into trays and trolleys which can be moved to a wrapping room for packing and shrink wrapping located in a different area

in the department. After the shrink wrapping process the final product is packed into rail cartons, which are then moved to the Despatch Department.

The visual representation of the process, as can be seen from Figure 2.2, highlighted the areas of waste, e.g. waste of time during waiting, work in progress, double handling etc.

The black arrows in Figure 2.2 indicate the direction of flow for the current process and the red arrows show the critical path (all tasks to be completed before starting the next activity [16]) flow for the process. The blue line in Figure 2.2 denotes two separate areas, namely, the filling room and a separate wrapping/auto cartner room.



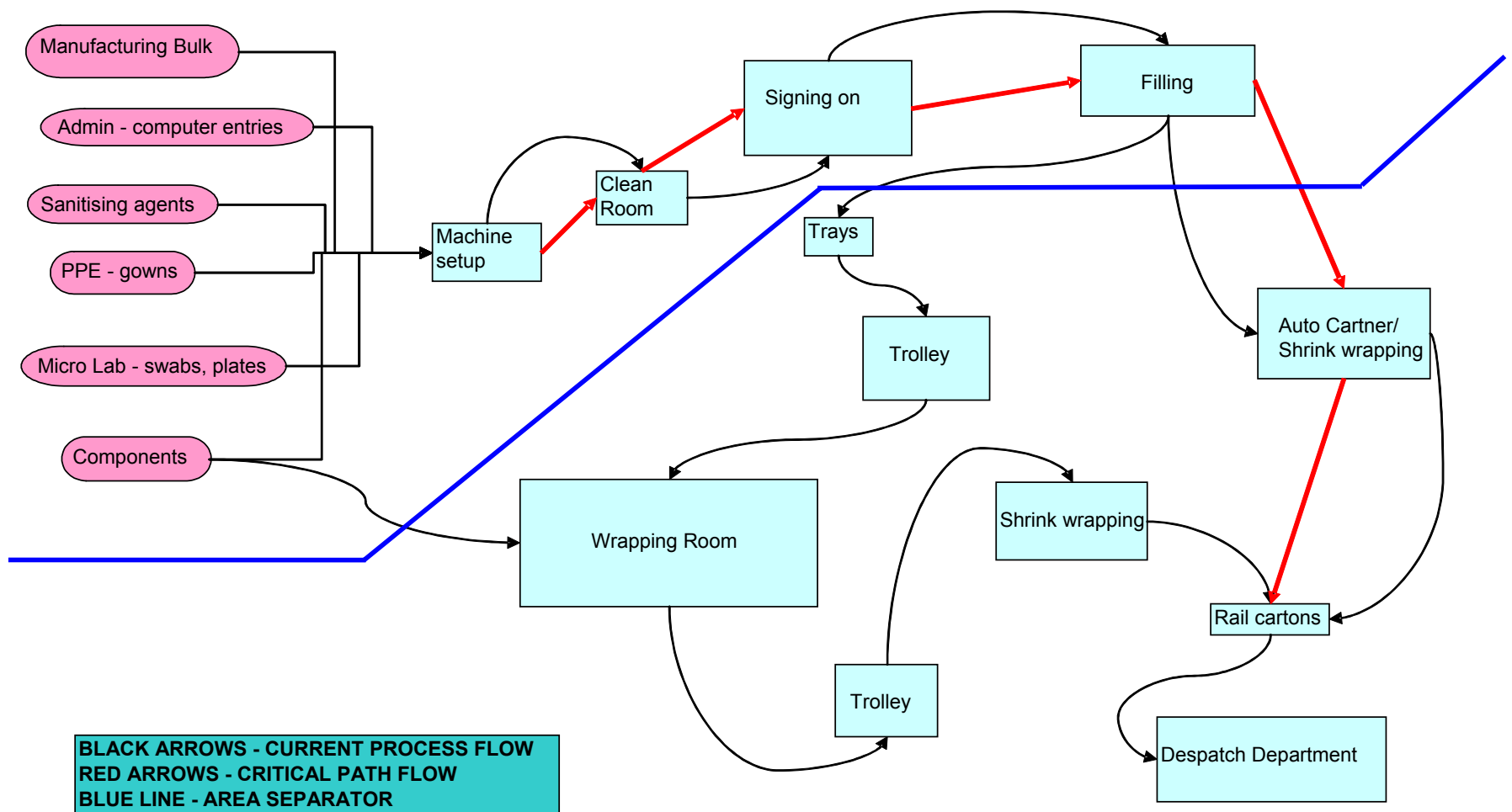

FIGURE 2.2 PROCESS FLOW DIAGRAM IN FILLING AND PACKING OPERATION FOR OINTMENTS AND CREAMS

### **2.1.3. INPUT PROCESS OUTPUT (IPO)**

Whether in the service or manufacturing industry, all business-related activities can be defined as some type of process. In a general sense, a process is defined as a blending of inputs to achieve some desired output [2]. Figure 2.3 shows the general IPO diagram for the ointment and creams filling operation.

For the study or investigation, the outputs of the process (namely ointments and cream filling) were selected for performance measurement. These performance measures should be able to measure how well the process performs with respect to customer (internal and external) requirements.

Performance measures have something to do with cost, time, defect or error rate, or some other critical quality measure that is associated with fitness of use by the customer. Performance measures must be metrics, since such measures must be able to indicate the state of the process, i.e. whether the process is improving or deteriorating. A metric can be defined as an objective indicator or measure that facilitates process monitoring [2]. A metric is therefore a performance measure that can be tracked and analysed by numerical methods such as statistics.

Figure 2.3 indicates two specific measurable outputs, namely “meeting standard time” and “product within specification”. The inputs for the process include material (bulk product and components), equipment, people, procedures, methods and environment (electricity, steam, air etc.). These diagrams do not reflect all of the performance measures that could be considered for this process. They do, however, focus attention on the critical performance measures or metrics. How well these outputs are measured is crucial in determining whether improvements have actually been made, as well as in planning for future improvements.

The IPO diagram focuses attention on outputs of a process that ultimately affect the customer. Traditionally the desired output of a process is linked to a Cause and Effect diagram.

One major outcome of the use of this tool is that it provides data on the current process and it focuses on the next process in the value stream:

- What it needs.
- When it needs it.
- Where it needs it.
- Quantity it needs.

It clearly highlights waste in the process (e.g. downtime and overtime), and focuses attention on what the customer wants and is prepared to pay for. The output variable forms the key for controlling the process that is finite and measurable, namely a quality product produced within standard time.

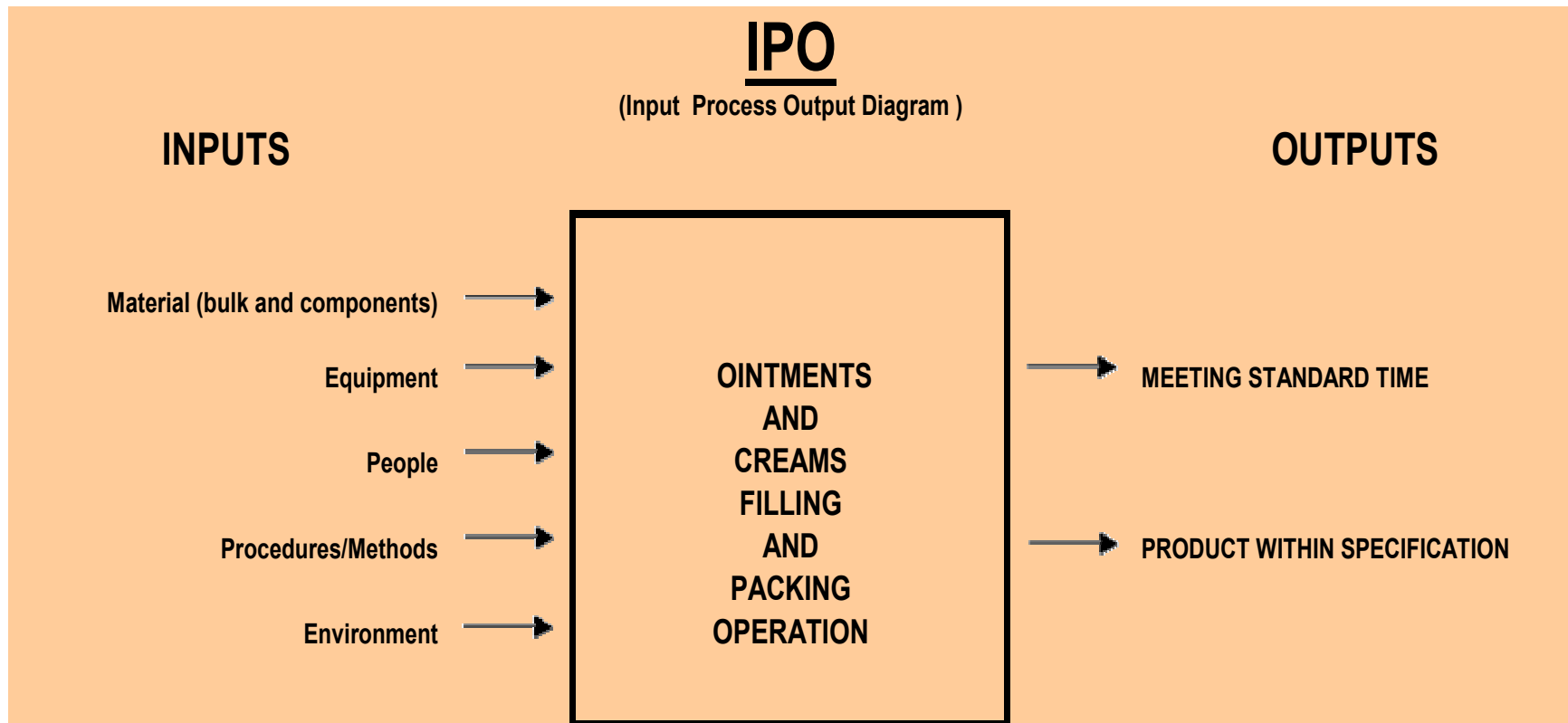

**FIGURE 2.3 INPUT PROCESS OUTPUT DIAGRAM (IPO)**

## **2.2. STEP 2: MEASURE**

### **2.2.1. CAUSE AND EFFECT DIAGRAM**

The overall objective of quality control is to improve quality. To control quality means identifying and correcting the causes of poor quality [9]. Furthermore, the dominant causes of defects (non-conformances) need to be isolated and subsequently removed. Process improvement involves taking action on the causes of variation. The number of possible causes for any given problem can be huge [9]. A useful graphical tool that is used to identify, display and examine possible causes of any observed condition is the Cause and Effect diagram. This tool is also known as an Ishikawa diagram or Fishbone diagram [17].

The desired outputs of the IPO diagram (Figure 2.3) are used as a starting point for the Cause and Effect diagrams. From these desired outputs of the process, namely meeting standard time and meeting specifications, team members of the process brainstormed all the possible factors, which could influence the outcomes or outputs of the process. The result of the brainstorming session is shown graphically in Figures 2.4 and 2.5.

To summarise, the steps taken to derive at these diagrams entailed:

- Identifying performance output/s from the IPO.
- Using brainstorming and the experience and knowledge of the team members generate all the possible factors that could affect the output of the process.
- Grouping the variables or causes into the following categories:
  - manpower.
  - materials.
  - machine.
  - method.
  - environment.

Each step is then reviewed, checking all the possible variables and causes related to the desired outputs of the process.

Once all the variables have been considered for each of the categories mentioned above, each variable is then classified (and thus labelled) either as a C, N, or X variable. The definitions of C, N, and X are as follows [2]:

C = those variables which must be held constant and require standard operating procedures to insure consistency.

N = those variables which are noise or uncontrolled variables and which cannot be held constant.

X = those variables considered to be key process (or experimental) variables to be tested in order to determine what effect each has on the outputs and what their optimal settings should be to achieve customer-desired performance.

The classifications of the variables are shown in Figure 2.4 and 2.5 by green stars. For each variable labelled with a “C” there should be a standard operating procedure (SOP) written for the process that details how the variable will be controlled and held as constant as possible. The SOP is the mechanism by which a “C” variable is held constant.

Variability in the performance measure (output) is to a great degree a reflection of the variability occurring in the input variables. Thus, the more input variables that can be controlled, the better the control of the performance measure. Unfortunately, there are variables that are extremely difficult to hold constant (the “N” variables). From Figure 2.5 examples of “N” variables are disciplined staff and machine fitter experience. The performance measure ultimately must be made ‘robust’ against these noise variables.

The only “X” variable from Figures 2.4 and 2.5 is humidity. The effect humidity has on the process is unknown and experimentation should be done on this “X” variable.

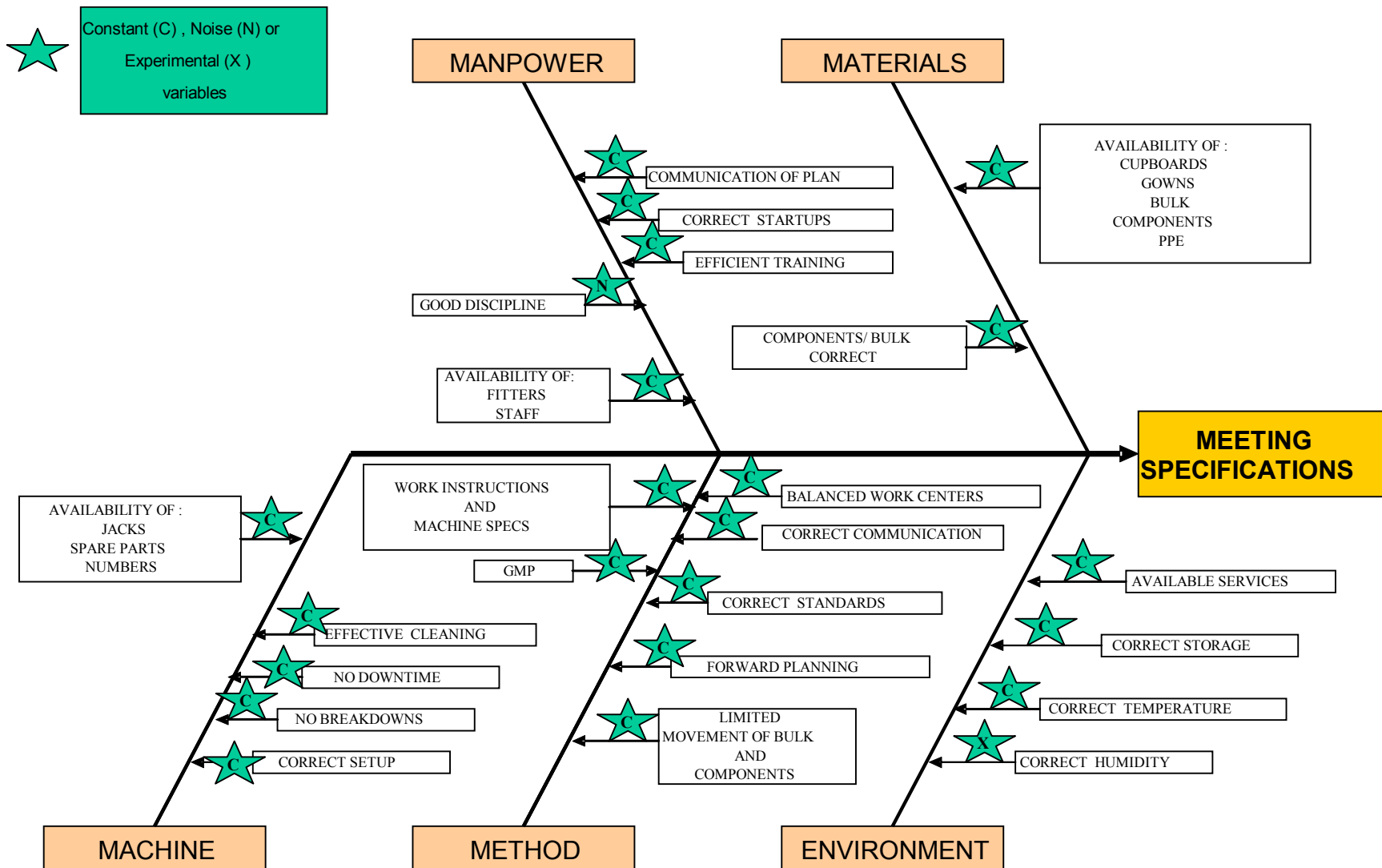

**FIGURE 2.4 CAUSE AND EFFECT DIAGRAM FOR MEETING SPECIFICATION**

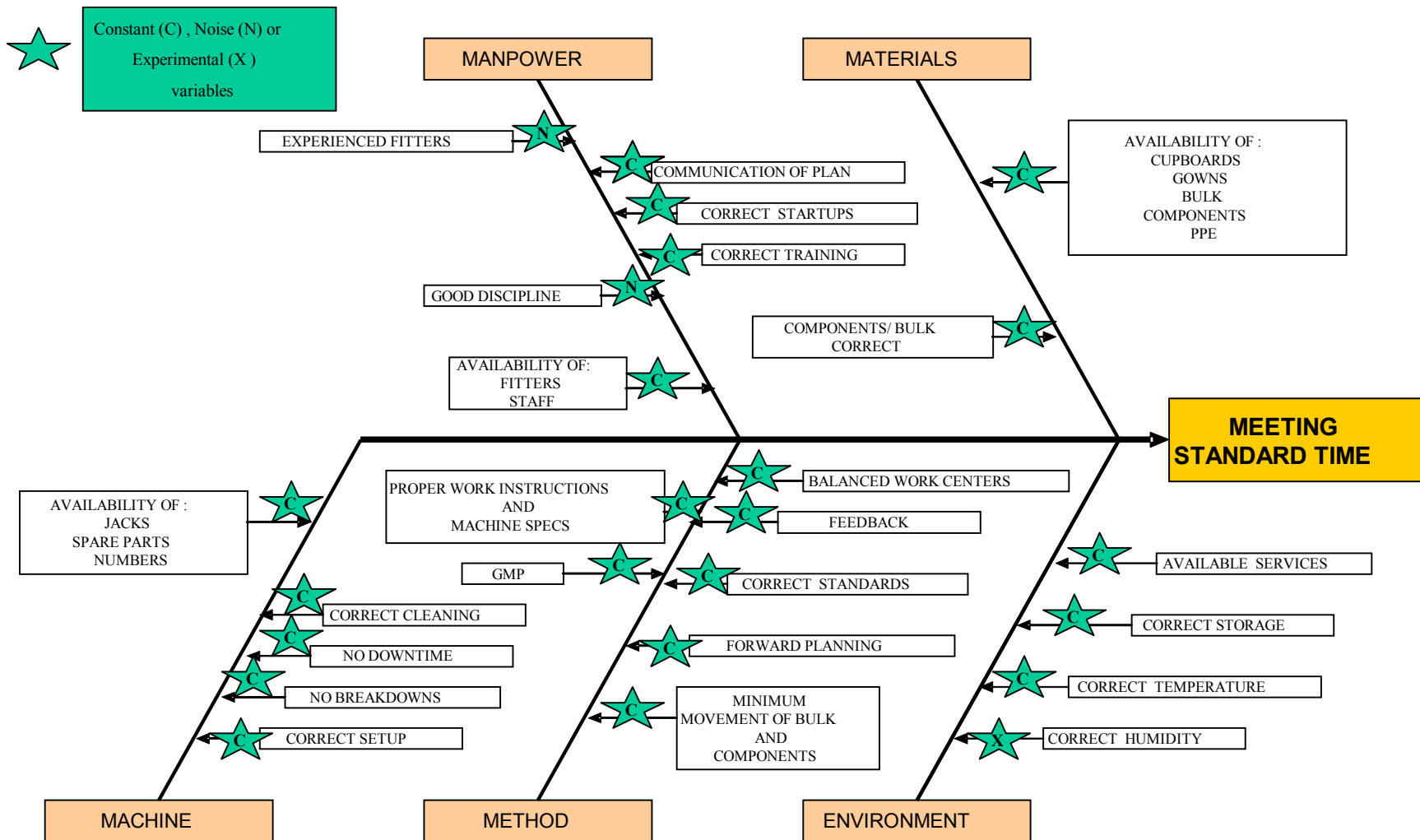

FIGURE 2.5 CAUSE AND EFFECT DIAGRAM FOR MEETING STANDARD TIME



Cause and Effect diagrams have a number of uses. The Cause and Effect diagram, once created, acts as a record of the process. The Cause and Effect diagram is a living document, which when new information is known, can be updated accordingly. It is therefore a display of the current level of understanding of the process as well as a reflection of the existing level of technology as understood by the team. The final diagram should display every variable known to the process that may affect the performance measure – the “head” of the diagram.

To meet standard time (following from the Cause and Effect diagram Figure 2.5) one area of focus for the process was to identify waste in the process. By focusing on each of the group variables, waste in the current process can be identified and can be managed to reduce such waste in order to supply the customer with the required product or service on time.

Twelve areas of waste [17] can be identified in a process namely:

- overproduction.
- waiting time (downtime).
- transportation.
- inappropriate processing.
- unnecessary motion.
- defects – internal, external, appraisal and prevention.
- lost opportunities.
- regulation violations.
- excessive turnover.
- Inappropriate/inadequate training.
- improvement initiative with no follow through.

To identify the most important areas of waste to improve first in the ointments and creams filling operation, data was collected over a period of two months. The results of these findings are presented in the form of a Pareto graph (Graph 2.1).

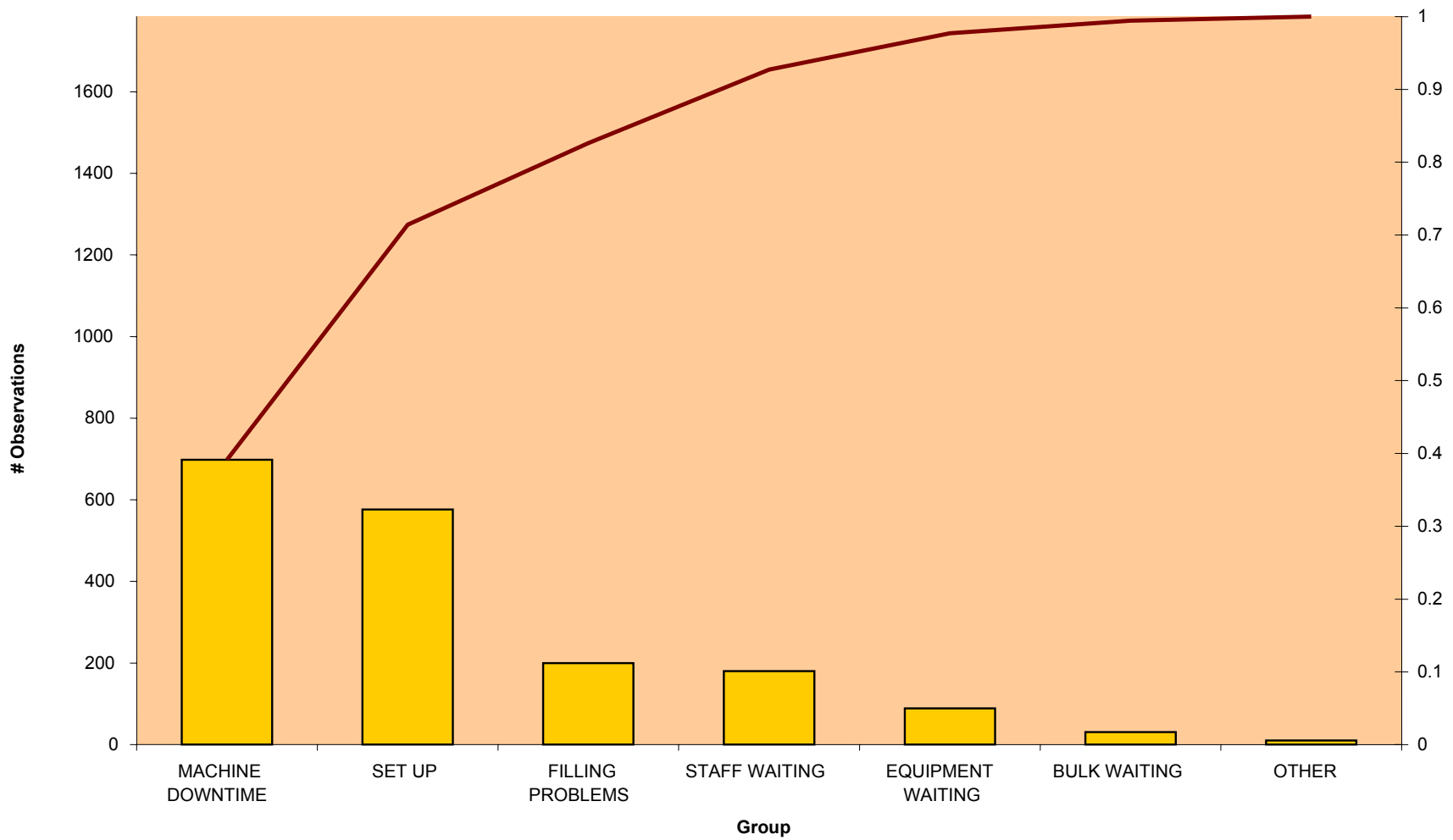

**GRAPH 2.1 PARETO GRAPH OF DOWNTIME**

A Pareto diagram is a bar chart and a cumulative line chart in this instance for non-numerical category descriptors whose bars are in descending order and is used to identify and separate the most frequently occurring categories from the less important categories. The left axis of Graph 2.1 shows the number of occurrences for each bar on the graph. The right axis on the Graph 2.1 shows the cumulative divisions for the line graph from zero to 1 (100%). From Graph 2.1 it is evident that machine downtime cause approximately 40% of the total downtime for the process, followed by set up times that result of approximately 30% of downtime for the operation. It is important to note that the set up downtime recorded in Graph 2.1 is the unplanned set up time (set up time that takes longer than the planned standard set up time). By focusing on these two identified problems, more than 70% (cumulative black line in Graph 2.1) of the total downtime of the process could be resolved, which in turn will result that standard time could be achieved as identified by Figure 2.5.

Consulting with staff and perusal of the Cause and Effect diagram (Figure 2.5) the reasons for the high percentage machine and set up downtime the following reasons were given:

Incorrect set up of machine due to lack of work instructions and improper training. By taking longer to set up the machine, the machine fitters are not available when a machine breaks down, which lead to machine downtime. By setting up a machine correctly in the first place will result in fewer downtime or stoppages during to filling problems, which in turn will result in meeting standard time.

To assist and resolve these downtime issues, graphically illustrated working procedures have been designed (see Figure 2.6 and 2.7). A work instruction is a guide to standardise any task in the work place and it guides the operator in how the task should be done and also explains the best way to perform a task. By graphically illustrating work instruction documents the procedures guide the operator on how to perform a given task. Work instructions thus standardise work methods to drive out any variation in working methods and operations.

Work instructions are only as good as the adherence to the instructions. These work instructions must be concise and in a format that is easy to understand for all concerned (e.g. diagrams or pictures). These work instructions could be utilised as an aid to training when inducting new staff to the process. Following work instructions in the process lead to the correct set up and operation of the machines and could reduce the two main areas of downtime in the process as identified by Graph 2.1. Figures 2.6 and 2.7 show how graphically a tube holder can be replaced and how a turntable of the tube holder can be adjusted. These two examples are part of the graphical illustration of the entire machine set up process. The operators could follow these easy steps to set up the machine correctly each time. Following standard work instructions cause less variation in the process which leads to meeting standard time.

# TONAZZI

## TUBE LOADER

Replace tube loading part (5.5) with the new size.

To adjust, put a tube in the tube loading part (5.5) and carry out the following operation:

- between chute (5.1) and loading part (5.5) let a clearance of 2-3 mm and then, lock chute by the two screws (5.12).
- after unlocking the fixing screws (5.11), align chute (5.1) with tube loading part (5.5) by the 2<sup>nd</sup> screw (5.10).
- align side (5.2) and upper (5.3) guides to obtain a clearance of 3-4 mm so that tubes can easily roll on chute (5.1).
- unlock screws (5.9). To adjust the 1<sup>st</sup> screw (5.7), act on collar (5.8) by means of the supplied key.

Regulate the tube loading part (5.5) so that its lower side, when in vertical position, is 2-5 mm over the tube holder (4.2).

## CAPSIZED TUBE CONTROL

Photocell (5.4) has to be positioned so that light is in the middle of the tube diameter.

In case of capsized tube, the machine stops before the tube is introduced in the tube holder.

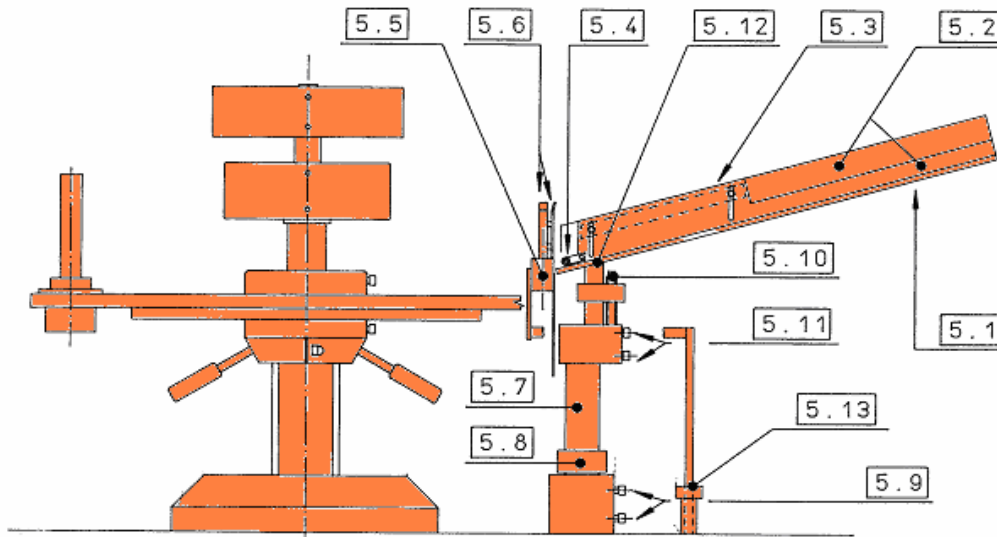

**FIGURE 2.6 WORK INSTRUCTIONS TO REPLACE TUBE HOLDER**

# TONAZZI

## ADJUSTMENTS

### TUBE HOLDER

Replace tube holder (4.2) with the one suitable for the new tube size.

### TUBE HOLDER TURNTABLE

#### HEIGHT ADJUSTMENT

Unlock both screws (4.4) on the hub of turntable (4.1) and collar locking screw (4.6), then act on the collar arms (4.5).

The open bottom of the tube has to be 370 mm over the machine plane.  
It is possible to vary such a distance of some millimeters depending on the desired sealing height. Then, lock screws (4.4 and 4.6).

**IMPORTANT:** when lifting turntable (4.1) pay attention not to knock it against tube loader or chute.

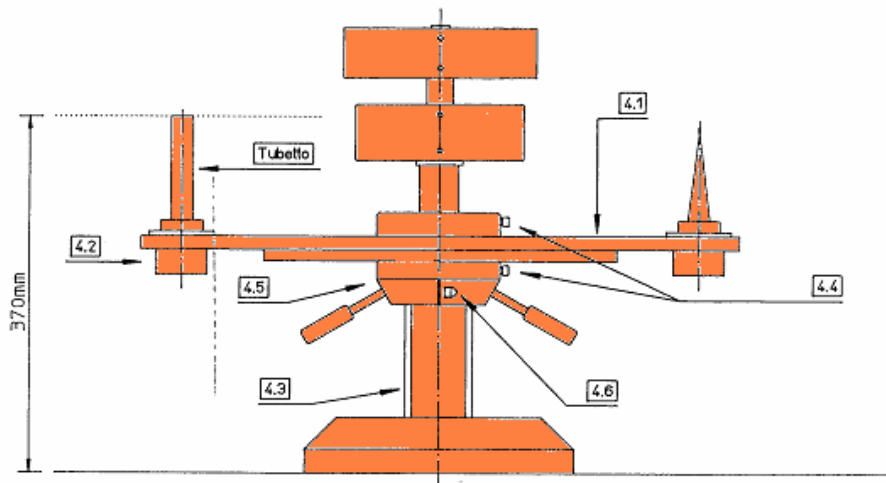

**FIGURE 2.7 WORK INSTRUCTIONS TO ADJUST TURN TABLE HEIGHT**

### 2.2.2. THE 5S PHILOSOPHY

5S is the Japanese concept for house keeping [4]. 5S is a system to help organise your workplace and to expose all types of waste discussed previously in Section 2.2.1. 5S is the starting block for any Six Sigma project and prepares the workplace for a professional approach by getting rid of unneeded items and cleaning up. 5S focuses on standardising work methods and to improve the flow of work through the work centre. By following a simple step approach, it will lead to reducing variation in all its forms.

The 5S is five Japanese words that embrace this style namely:

- Seiri – organise by throwing away the unnecessary and put things in order, (remove what is not needed and keep what is needed).
- Seiton – tidy what is left behind and arrange properly (place things in such a way that they can easily be reached whenever needed).
- Seiso – clean thoroughly (keep things clean and polished; no trash or dirt in the workplace).
- Seiketsu – set standards (purity – maintain cleanliness after cleaning).
- Shitsuke – maintain or sustain the standards over a period of time in a disciplined way (commitment to inspire pride and adherence to standards established).

A maturity assessment was done in the ointments and cream filling process to determine the level of 5S maturity for the area regarding the 5S philosophy. The assessment results were entered into a TRACC® program [18] and the results of the assessment are given in the form of a progress chart (Figure 2.8) and radar graph (Graph 2.2). From Figure 2.8 it can be seen that the 5S philosophies are broken down into five stages. The first stage is the Chaos stage; the process must still work on the four areas indicated by a red block before moving on to the stage 2 (clear up). The green blocks for stage one indicate that the operation has reached the maturity to move to the next stage of the process. The focus will thus be to reach maturity for all

the seven focus areas. Graph 2.2 displays the results obtained from Figure 2.8 graphically (area covered with blue colour) relative to the centre point. From Figure 2.8 and Graph 2.2 the areas to focus on in the operation are:

- Removing unnecessary items and therefore waste.
- Cleanliness (Seiso).
- Standards (Seiketso).
- Support Systems (Shitsuke).





## TRACC Progress Chart

### 5S (v3)

Area: Pharmacare

Assessor: Admin

	Stage 1 Chaos	Stage 2 Clear-Up	Stage 3 Cleaning with Meaning	Stage 4 Locations and Limits	Stage 5 Sustain and Improve
1.Strategy	<div style="width: 100%; height: 20px; background-color: green;"></div>	<div style="width: 25%; height: 20px; background-color: green;"></div>			
2.Unnecessary Items	<div style="width: 100%; height: 20px; background-color: red;"></div>				
3.Cleanliness (Seiso)	<div style="width: 100%; height: 20px; background-color: red;"></div>				
4.Storage (Seiton)	<div style="width: 100%; height: 20px; background-color: green;"></div>	<div style="width: 25%; height: 20px; background-color: green;"></div>			
5.Standards (Seiketso)	<div style="width: 100%; height: 20px; background-color: red;"></div>				
6.Support (Shitsuke)	<div style="width: 100%; height: 20px; background-color: red;"></div>				
7.Training & Development	<div style="width: 100%; height: 20px; background-color: green;"></div>	<div style="width: 10%; height: 20px; background-color: green;"></div>			

FIGURE 2.8 5S PROGRESS CHART

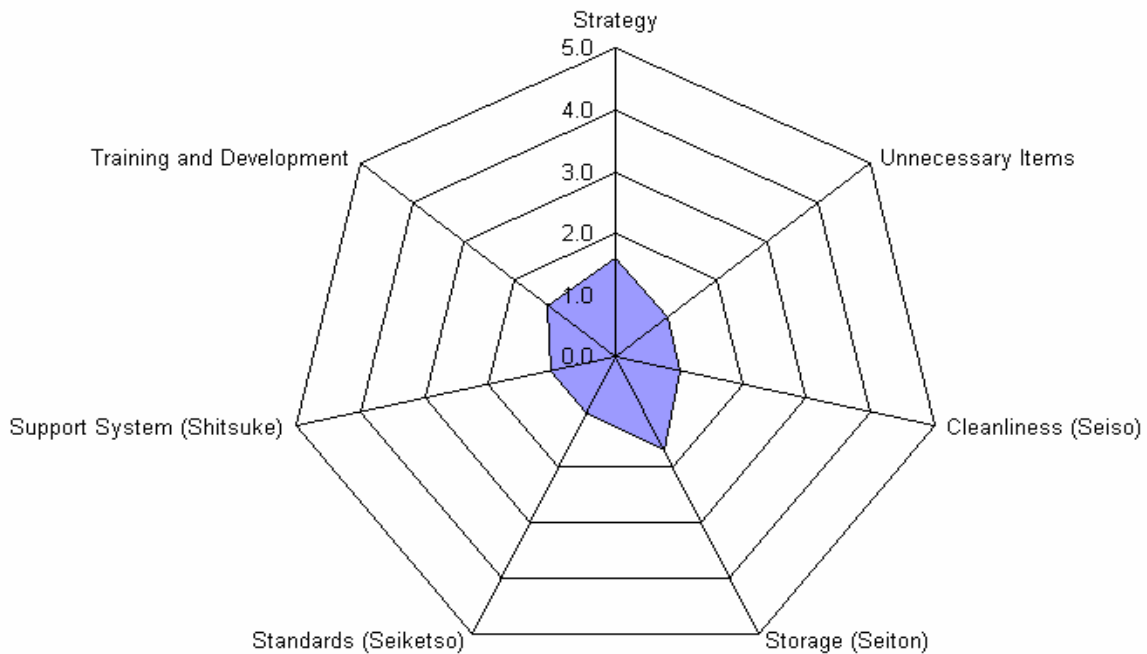

**GRAPH 2.2 5S RADAR PROGRESS CHART**

Figure 2.9 shows an example of how the introduction of the 5S system had transformed the operation. The “before” photo shows that communication and other performance notes that were pasted on the window of the room. The “after” photo shows how the performance board is being maintained in the room. By having visual displays in the area show employees how the process is performing and is a visual indication of what is expected for the next production stage.

Implementation of the 5S system highlights different forms of waste and by eliminating these waste creates a cleaner and safer work place. 5S improved the workers pride of their area and gave the workers the opportunity to take ownership of

their work area by updating the notice board on a regular interval during the shifts. 5S established a culture of discipline and order for future projects and reduced time wasted while searching for items. 5S aided in delivering products in the required specified time.



**“BEFORE” PHOTO**



**“AFTER” PHOTO**

**FIGURE 2.9 “BEFORE” AND “AFTER” PHOTO’S OF 5S IMPLEMENTATION**

## **2.2.3. MEASUREMENT SYSTEMS ANALYSIS (MSA)**

### **2.2.3.1. Introduction**

Using advanced electronic communication and computer technologies, society is inundated with vast amounts of data, which is typically stored in high-speed computers. In its raw form, this data is of little value. However, when manipulated with statistical tools, the data can be transformed into valuable information (numeric and/or graphic). This knowledge is vital for drawing conclusions and making decisions. Since statistical tools are required to gain useful information or knowledge from data, the “Internet Age” is rapidly generating the statistical age of tomorrow.

The variability in any process arises from a variety of sources: machine, operator, materials, environment, methodology, and measurement, to name a few. In any data collection effort, it is important to understand that there may be variability in the measurement system itself. Understanding and quantifying this measurement error is an important aspect that is often overlooked when one is charting the performance of a process [19].

### **2.2.3.2. Measurement Study**

In any process there is variability in the product or service being measured, as well as variability in the way the product or performance is being measured. In any measuring device or system, there are three desired properties [19]:

- Accuracy – the ability to produce an average measured value, which reflects the true value.
- Precision – the ability to repeatedly measure the same product and obtain the same results.
- Stability – the ability to repeatedly measure the same product over time and obtain the same average measured value.

The purpose of a gage or measurement study in the ointments and creams filling room is to assess how much, if any, variation is associated with the measurement system (one decimal scale) and to compare it to the total process variation [20]. The measurement study conducted relates only to the product within specification process output described in Section 2.1.3.

Actual method:

Measurement System Analysis (MSA) data was performed on SPC XL Application Software [21] using Microsoft Excel. Data is captured on a template (Table 2.1 and Table 2.3). The results of the Data were reproduced in the form of a MSA template (Table 2.2 and Table 2.4). The results from the MSA templates are presented in the following MSA Xbar R format:

The screenshot shows an Excel spreadsheet titled "MSA One Decimal.xls". The main content is a table with the following structure:

Source	Variance	Standard Deviation	% Contribution
Total Measurement (Gage)			
Repeatability			
Reproducibility			
Product (Part-to-Part)			
Total			

USL	
LSL	
CR	
Precision to Total Ratio	

Where the source column represent:

**Total Measurement (Gage):** defined as measurement error which is composed of repeatability and reproducibility error.

**Repeatability:** defined as the variation obtained by the same instrument on the same product or service for repeated measurements (i.e. the variability within operator/device combination).

**Reproducibility:** defined as the variation obtained due to differences in people taking the measurements (i.e. variability between operators).

**Product (Part-to-Part):** defined as variation between parts.

Total: defined as total variation composed of Measurement (Gage) and product (Part-to-Part) variation.

USL (upper specification limit): defined as the highest value of a product dimension or measurement which is acceptable.

LSL (lower specification limit): defined as the lowest value of a product dimension or measurement which is acceptable.

CR (precision to tolerance Capability Ratio): defined as  $6\sigma$  measurement /USL-LSL [2]. The Rule of Thumb (ROT) for CR is:

If  $CR \leq 0.10$ , the measurement system is adequate;

If  $CR \geq 0.30$ , the measurement system is unacceptable [21].

Precision to Total Ratio: defined as the standard deviation of total measurement (gage) / standard deviation of total. If the value is more than 0.1 the measuring system needs to be examined due to variation inherent in the measuring system [2].

Xbar: defined as sample mean [4].

Xbar R Graphs: this graph is the most commonly used statistical process control procedure. It is used to monitor process behaviour and outcome over time. Xbar R charts draw a control chart for subgroup means and a control chart for subgroup ranges in one graphic. Interpreting both graphs together allows you to track both process center and process variation and detect the presence of special causes [4].

Data capturing was done in the ointments and creams filling department.

Data was collected by considering four different operators each taking two measurements of a different filled cream tube (numbered 1-20) on a one decimal scale. All the operators in the same room (environment constant) used the same scale. Data reproduced is in the form of a Measurement System Analysis (MSA) Data Template (Table 2.1).



Upper Specification Limit: 16.0g  
 Lower Specification Limit: 15.0g

Tube #	Operator 1 Rep 1	Operator 2 Rep 1	Operator 3 Rep 1	Operator 4 Rep 1
1	15.5	15.5	15.5	15.4
2	15.4	15.5	15.4	15.4
3	15.4	15.4	15.5	15.3
4	15.6	15.5	15.5	15.5
5	15.5	15.5	15.5	15.5
6	15.5	15.5	15.5	15.5
7	15.5	15.5	15.5	15.5
8	15.7	15.7	15.5	15.6
9	15.5	15.4	15.4	15.4
10	15.5	15.5	15.4	15.5
11	15.5	15.5	15.4	15.4
12	15.4	15.4	15.4	15.4
13	15.8	15.7	15.7	15.7
14	15.5	15.5	15.5	15.4
15	15.6	15.6	15.5	15.5
16	15.5	15.5	15.4	15.4
17	15.7	15.7	15.6	15.5
18	15.5	15.4	15.5	15.4
19	15.7	15.7	15.7	15.7
20	15.5	15.5	15.5	15.4

**TABLE 2.1 MSA DATA FOR ONE DECIMAL SCALE (tube mass in grams)**

From Table 2.2 it is evident that the precision to tolerance Capability Ratio (CR) is 0.1875. The calculated CR value is between the two ROT values and need further testing to come to a conclusion of acceptance or rejection of the measurement system. From Table 2.2 the precision to total ratio of 0.3507, which is also above the limit of 0.1, indicates that further attention needs to be given to the one decimal scale, which causes variation in recorded results. For this reason, it was decided to use a two decimal scale.

Microsoft Excel - MSA One Decimal.xls

File Edit View Insert Format Tools Data Window Help

Type a question for help

Reply with Changes... End Review...

E52 Create Microsoft Outlook Task

### MSA XbarR Method Results

Source	Variance	Standard Deviation	% Contribution
Total Measurement (Gage)	0.000977	0.03125	12.30%
Repeatability	0	0	0.00%
Reproducibility	0.000977	0.03125	12.30%
Product (Part-to-Part)	0.006964	0.083448089	87.70%
Total	0.00794	0.089107497	100.00%

USL	16.00
LSL	15.00
CR	0.1875
Precision to Total Ratio	0.3507

MSA Template / Sheet1 / MSA Analysis - XbarR / MSA- Misclassification / MSA- Measure

start FLASH DISK (E:) Dissertation SIX SIGMA.doc - Micr... Microsoft Excel - MSA... 09:14 AM

TABLE 2.2 MSA Xbar R METHOD RESULTS FOR ONE DECIMAL SCALE

The measurement of the output of the filling operation was repeated, with five operators using a two decimal scale. The data is shown in Table 2.3 and the results depicted in Table 2.4.

The calculated CR value using a two decimal scale is 0.0718, which indicate an adequate measurement system ( $CR \leq 0.1$ ).

Measurement errors have two components, namely repeatability and reproducibility, defined previously. The ROT for both of these two measurement errors should be less than 0.10 in order for the measurement error to be acceptable [17]. From Table 2.4 it is noticed that both the repeatability value and the reproducibility value is below 0.10, which indicates that measurement error is acceptable between and within operators using a two decimal scale. Reproducibility using a one decimal scale (Table 2.2) was also acceptable indicating that the operators follow a similar weighing technique with acceptable levels of reproducing and repeating experiments.

Upper Specification Limit: 16.00g  
 Lower Specification Limit: 15.00g

TUBE #	OPERATOR 1		OPERATOR 2		OPERATOR 3		OPERATOR 4		OPERATOR 5	
	Rep 1	Rep 2	Rep 1	Rep 2	Rep 1	Rep 2	Rep 1	Rep 2	Rep 1	Rep 2
1	15.48	15.48	15.46	15.46	15.47	15.47	15.46	15.47	15.47	15.47
2	15.45	15.45	15.42	15.42	15.43	15.44	15.44	15.44	15.43	15.44
3	15.39	15.39	15.38	15.37	15.38	15.38	15.39	15.39	15.47	15.38
4	15.50	15.50	15.46	15.47	15.49	15.48	15.48	15.48	15.49	15.48
5	15.52	15.51	15.48	15.48	15.50	15.50	15.50	15.51	15.50	15.50
6	15.51	15.51	15.49	15.49	15.51	15.51	15.51	15.51	15.51	15.51
7	15.51	15.51	15.49	15.48	15.49	15.50	15.50	15.50	15.50	15.50
8	15.64	15.64	15.62	15.61	15.62	15.63	15.61	15.62	15.62	15.63
9	15.45	15.45	15.42	15.41	15.43	15.43	15.43	15.43	15.44	15.43
10	15.47	15.47	15.46	15.45	15.46	15.47	15.48	15.48	15.47	15.46
11	15.48	15.49	15.46	15.46	15.47	15.47	15.49	15.48	15.47	15.47
12	15.40	15.41	15.38	15.37	15.38	15.40	15.40	15.40	15.39	15.40
13	15.72	15.72	15.71	15.70	15.71	15.73	15.72	15.72	15.71	15.72
14	15.46	15.47	15.44	15.45	15.45	15.46	15.46	15.45	15.46	15.46
15	15.56	15.55	15.52	15.51	15.54	15.54	15.55	15.55	15.54	15.54
16	15.49	15.49	15.46	15.47	15.48	15.47	15.49	15.47	15.50	15.50
17	15.61	15.61	15.57	15.58	15.59	15.59	15.60	15.60	15.60	15.60
18	15.42	15.42	15.40	15.39	15.41	15.41	15.40	15.39	15.41	15.40
19	15.69	15.69	15.65	15.64	15.67	15.67	15.68	15.68	15.68	15.68
20	15.52	15.51	15.49	15.49	15.50	15.49	15.50	15.50	15.50	15.50

TABLE 2.3 MSA DATA TEMPLATE FOR TWO DECIMAL SCALE (tube mass in grams)

Microsoft Excel - MSA Two Decimal.xls

File Edit View Insert Format Tools Data Window Help

Type a question for help

149

### MSA XbarR Method Results

Source	Variance	Standard Deviation	% Contribution
Total Measurement (Gage)	0.000143	0.011976028	2.03%
Repeatability	2.55E-05	0.005053191	0.36%
Reproducibility	0.000118	0.01085774	1.67%
Product (Part-to-Part)	0.006921	0.083191326	97.97%
Total	0.007064	0.084048926	100.00%

USL	16.00
LSL	15.00
CR	0.071856
Precision to Total Ratio	0.142489

MSA TWO DECIMAL \ MSA Analysis - XbarR \ MSA- Misclassification \ MSA- Measuremer

Ready

start FLASH DISK (E:) Dissertation SIX SIGMA.doc... MSA One Deci... MSA Two Decim... 09:17 AM

**TABLE 2.4 MSA XbarR METHOD RESULTS FOR TWO DECIMAL SCALE**

The histogram below (Graph 2.3) shows how the 20 measurements of the one decimal scale are dispersed. The unit of measurement is grams. It was found that the average weight of the tubes was 15.6 grams.

Normal Distribution  
 Mean = 15.6  
 Std Dev = 0.1028

**Histogram**

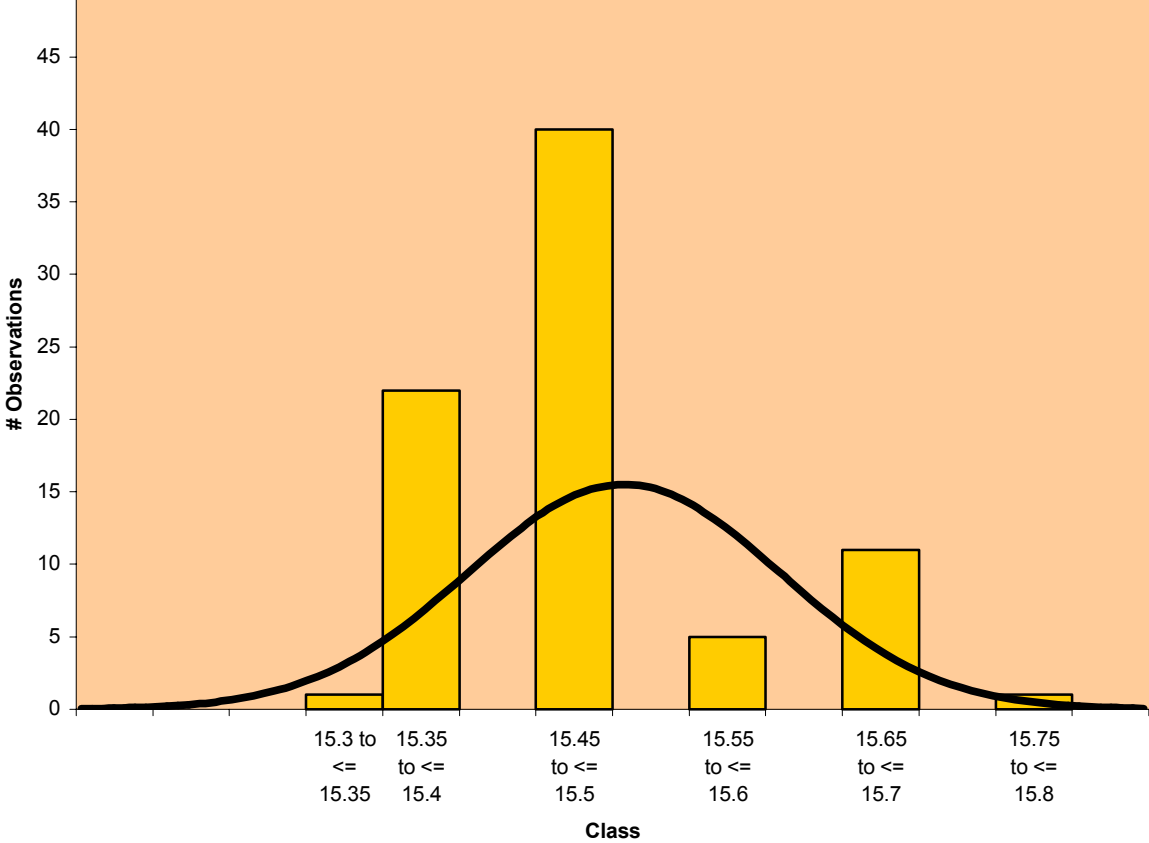

**GRAPH 2.3 HISTOGRAM OF TUBES WEIGHT (in grams) USING ONE DECIMAL SCALE**

Graph 2.3 depicts the frequency of the weights of the tubes in the form of a bar graph. Graph 2.3 shows that the data obtained from 20 observations using a one decimal scale vary between 15.3 g to 15.8 g per tube with a mean weight of 15.6 g.

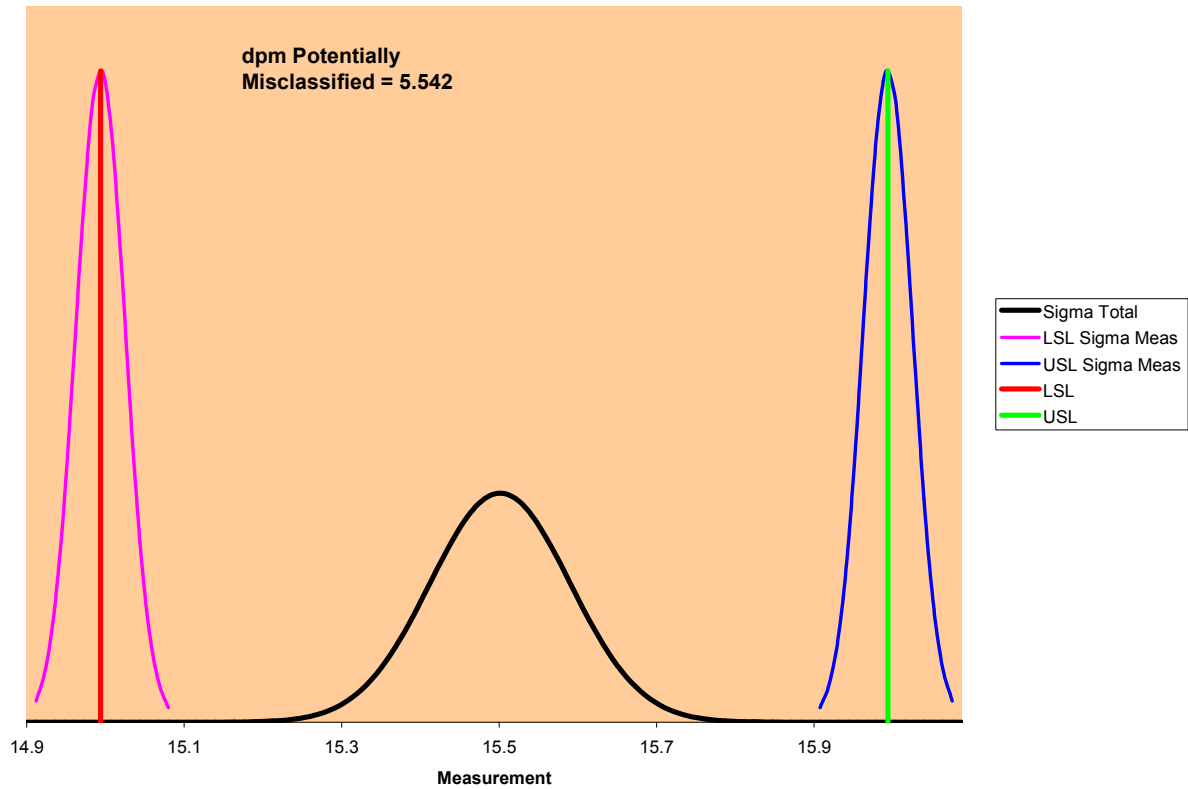

**GRAPH 2.4 MISCLASSIFICATION DUE TO MEASUREMENT ERROR USING ONE DECIMAL SCALE**

From Graph 2.4 it is noticed that the measurements taken relates to a normal distribution of data (black line) with a dpm potentially of 5.542. Comparing Graph 2.4 with Graph 2.6 the dpm potentially decrease to only 0.34. This factor shows the variation that exists between a one and two decimal scale.

Normal Distribution  
 Mean = 15.50  
 Std Dev = 0.0873

### Histogram

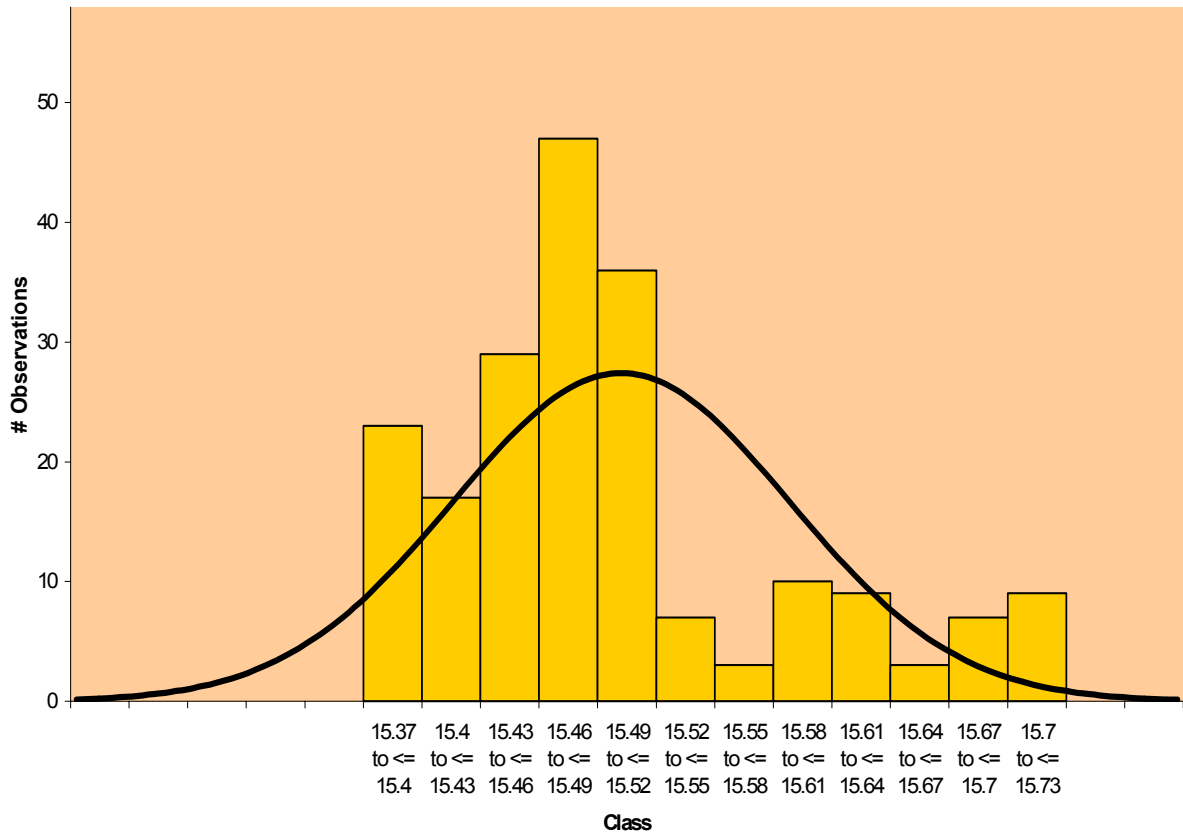

**GRAPH 2.5 HISTOGRAM OF TUBES WEIGHT (in grams) USING TWO DECIMAL SCALE**

Graph 2.5 depicts how the 20 duplicate measurements using a two decimal scale are distributed. Graph 2.5 shows that the data obtained vary between 15.37 g to 15.73 g per tube with a mean weight of 15.50 g (normal distribution).



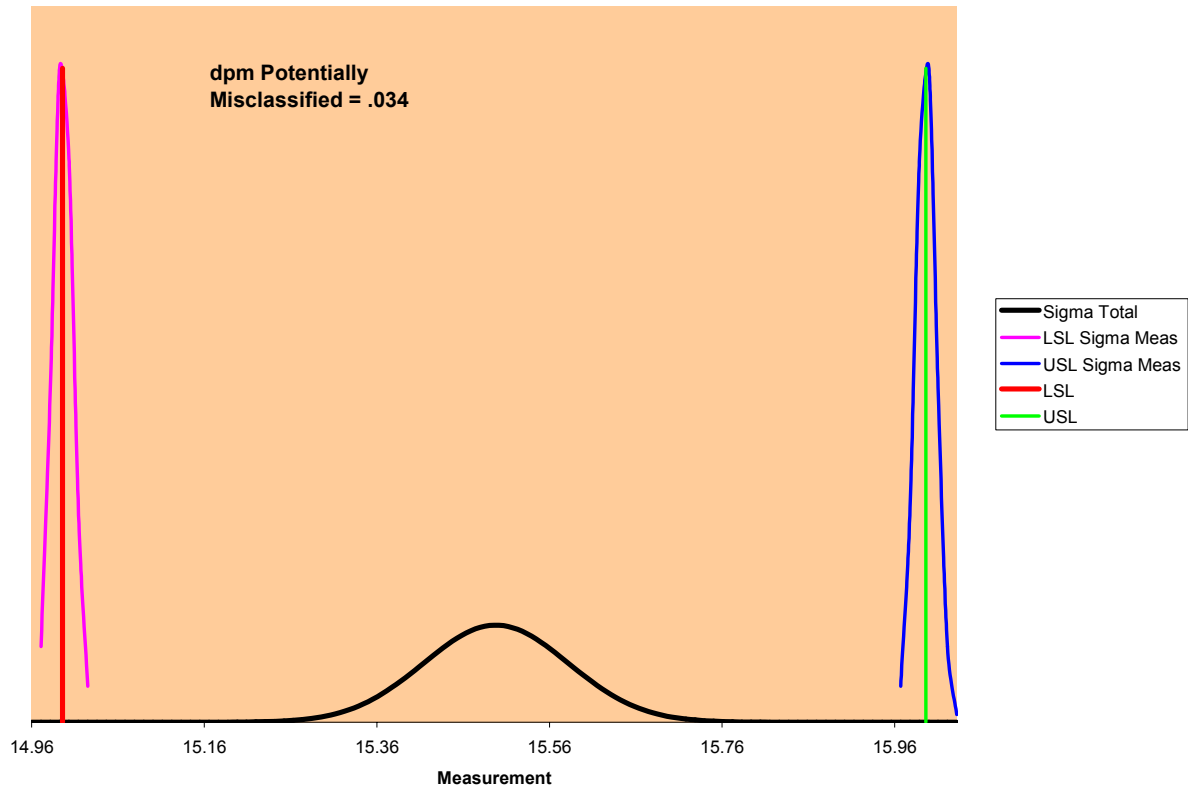

**GRAPH 2.6 MSA MISCLASSIFICATION DUE TO MEASUREMENT ERROR USING TWO DECIMAL SCALE**

The relationship between Sigma, DPMO, yield and  $C_{PK}$  is illustrated in Tables 1.1 and Table 1.2. In these tables the assumptions are made that the standard sigma shift of 1.5 is appropriate, the data is normally distributed, and the process is stable. If using DPMO, convert it to a decimal value by dividing by 1000000. Multiply that decimal by 100 and yield (%) is given. The decimal value calculated could be looked up in a standard normal curve (Z) table to get the corresponding Z value, which is the long term Z. To convert to short term Z, which is the Sigma level, the following formula was used [4]:

$$Z \text{ (short term)} = Z \text{ (long term)} + 1.5$$

To determine  $C_{PK}$  use the following formula:

$$C_{PK} = Z \text{ (short term)} / 3 \text{ [4].}$$

An USL of 16.00 g and a LSC of 15.00 g (red lines) is set for the process that will give a potential dpm of 0.034 (Graph 2.6). This dpm equates to a sigma level of 5.4 and a sigma capability value of 5.5 (as explained above) [22].

For a one decimal scale, the dpm equates to a 4.7890 sigma level and a  $C_{PK}$  value of 1.5963.

#### **2.2.4. PROCESS CHARACTERISATION**

Process characterisation involves creating a description of the process and establishing initial values for the input and output parameters of the process. The description of the process should establish a baseline for equipment, materials and methods used for the process. This description should allow someone to replicate the conditions and procedures necessary to successfully accomplish the objectives of the process. Process characterisation also involves developing an understanding of the basic scientific and engineering principles upon which the process is based. An understanding of these principles can lead to more informed decisions during the process optimisation and control phase.

Excessive variation of critical product dimensions is a major contributor to poor quality. Customers today demand uniform, defect-free products that necessitate testing processes in order to identify parameter settings, which minimise variability [22].

The purpose of this tool is to verify the Key Process Output Variables (KPOV) with the Key Process Input Variables (KPIV) and to determine the relationship between them. Key process variables can be defined as some factor (e.g. machine speed) that is crucial in causing variation in a process [4]. These process variables could be introduced to a process (KPIV) or be a result (KPOV) of such a process.

In the absence of any data regarding how machine filling speed, stirrer speed and filling nozzle size affect the output of the filling operation, an experiment was done to consider these possible interactions.

The Tonazzi filling machine was used for evaluation by varying filling rates and keeping either the stirrer rate or nozzle size constant in each experiment. The experimental run was performed with a batch of Skincalm® cream that was filled into

25 g tubes at a room temperature of 21.2 degrees Celsius (°C). Tables 2.5 - 2.7, illustrate the results obtained from these different settings.

A number of assumptions were made during the filling experiments, namely that:

- the bulk active is constant in composition;
- the conditions (temperature and humidity) are constant; and
- the machine variations are constant.

	Mass (g) for Filling Rate of 55 Tubes /min	Mass (g) for Filling Rate of 70 Tubes /min
	30.00	29.74
	30.01	29.79
	29.80	30.00
	30.00	29.71
	30.03	29.60
	29.80	29.60
	30.00	29.75
	30.00	29.73
	30.01	29.75
	30.03	29.75
<b>Mean</b>	29.97	29.74
<b>Standard Error</b>	0.028237091	0.035049172
<b>Standard Deviation</b>	0.089293523	0.110835213
<b>Sample Variance</b>	0.007973333	0.012284444
<b>Range</b>	0.23	0.4
<b>Minimum</b>	29.80	29.60
<b>Maximum</b>	30.03	30.00
<b>Sum</b>	299.68	297.42
<b>Count</b>	10	10

<b>Experimental Settings</b>	Filling Speed	55 or 70 Tubes /min.
	Stirrer Speed	34 rpm
	Nozzle Size	Small
	Product	Skincalm® (Batch E145963)

**TABLE 2.5 DATA, DESCRIPTIVE STATISTICS AND EXPERIMENTAL CONDITIONS - SMALL NOZZLE**

	Mass (g) for Filling Rate of 55 Tubes /min	Mass (g) for Filling Rate of 75 Tubes /min
	30.79	30.80
	30.62	30.81
	30.61	30.59
	30.60	30.59
	30.60	30.60
	30.78	30.42
	30.81	30.62
	30.80	30.81
	30.63	30.80
	30.62	30.40
<b>Mean</b>	30.69	30.64
<b>Standard Error</b>	0.029896116	0.049647647
<b>Standard Deviation</b>	0.094539821	0.156999646
<b>Sample Variance</b>	0.008937778	0.024648889
<b>Range</b>	0.21	0.41
<b>Minimum</b>	30.60	30.40
<b>Maximum</b>	30.81	30.81
<b>Sum</b>	306.86	306.44
<b>Count</b>	10	10

<b>Experimental Settings</b>	Filling Speed	55 or 70 Tubes /min.
	Stirrer Speed	34 rpm
	Nozzle Size	Standard
	Product	Skincalm®
		(Batch E145963)

**TABLE 2.6 DATA, DESCRIPTIVE STATISTICS AND EXPERIMENTAL CONDITIONS - STANDARD NOZZLE**

	Mass (g) for Filling Rate of 55 Tubes /min	Mass (g) for Filling Rate of 70 Tubes /min
	30.64	30.60
	30.80	30.60
	30.40	30.61
	30.59	30.59
	30.61	30.60
	30.60	30.40
	30.58	30.58
	30.60	30.59
	30.63	30.60
	30.62	30.60
<b>Mean</b>	30.61	30.58
<b>Standard Error</b>	0.030369941	0.019835434
<b>Standard Deviation</b>	0.096038187	0.06272515
<b>Sample Variance</b>	0.009223333	0.003934444
<b>Range</b>	0.4	0.21
<b>Minimum</b>	30.40	30.40
<b>Maximum</b>	30.80	30.61
<b>Sum</b>	306.07	305.77
<b>Count</b>	10	10

**Experimental Settings**

Filling Speed	55 or 70 Tubes /min.
Stirrer Speed	39 rpm
Nozzle Size	Standard
Product	Skincalm® (Batch E145963)

**TABLE 2.7 DATA, DESCRIPTIVE STATISTICS AND EXPERIMENTAL CONDITIONS - STANDARD NOZZLE**

Tables 2.8 - 2.10 reflects the Analysis of Variance (ANOVA) results for the three different scenarios investigated.

ANOVA

<i>Source of Variation</i>	<i>SS</i>	<i>df</i>	<i>MS</i>	<i>F</i>	<i>P-value</i>	<i>F crit</i>
Between Groups	0.25538	1	0.25538	25.21303	0.000089	4.413863
Within Groups	0.18232	18	0.010129			
Total	0.4377	19				

**TABLE 2.8 ANOVA: LOW STIRRING SPEED AND SMALL NOZZLE**

The calculated F-value for the two different filling speeds (between groups) is larger than the critical F-value, hence it can be concluded that there is a statistically significant difference between the actual mass of cream filled into the tubes when using two different filling speeds and when using a small nozzle size.

ANOVA

<i>Source of Variation</i>	<i>SS</i>	<i>df</i>	<i>MS</i>	<i>F</i>	<i>P-value</i>	<i>F crit</i>
Between Groups	0.00882	1	0.00882	0.525208	0.477944	4.413863
Within Groups	0.30228	18	0.016793			
Total	0.3111	19				

**TABLE 2.9 ANOVA: LOW STIRRING SPEED AND STANDARD NOZZLE**

The calculated F-value for the two filling speeds, using the standard nozzle and a low stirring speed is smaller than the critical F-value. In this case it was evident that there is therefore no statistically significant difference in the masses filled into the tubes under these experimental conditions.

ANOVA

<i>Source of Variation</i>	<i>SS</i>	<i>df</i>	<i>MS</i>	<i>F</i>	<i>P-value</i>	<i>F crit</i>
Between Groups	0.0045	1	0.0045	0.684006	0.41904	4.413863
Within Groups	0.11842	18	0.006579			
Total	0.12292	19				

**TABLE 2.10 ANOVA: STANDARD NOZZLE AND HIGH STIRRING SPEED**

The calculated F-value for the two filling speeds, using a standard nozzle and a high stirring speed is smaller than the critical F-value. In this case it was found there is therefore no statistically significant difference in the masses filled into the tubes under these experimental conditions.

The finding correlates with the Rule of Thumb (ROT) (i.e. a simplified, practical procedure that can be used in place of a formal statistical test that will produce approximately the same result) given by the formula:

$$\left( R_{\max}^2 / R_{\min}^2 \right) \left( \sqrt{n_1 + n_2} / 2 \right)$$

where: R = range  
n = data set

Calculated ROT values <10 generally indicates that there is no significant difference in the two sets of data points being compared. This is a good ROT when the sample sizes  $n_1$  and  $n_2$  are approximately equal and  $n_1 + n_2 / 2$  is less than 60 [2].

Using the formula, the following results were obtained:

**From Table 2.5**

Rmax =	0.40	n1 =	10
Rmin =	0.23	n2 =	10

Rmax x Rmax/Rmin x Rmin =	3.02457
(n1 + n2)/2 =	10
SQRT ((n1 + n2)/2) =	3.16228

Shift in variation = (Rmax x Rmax / Rmin x Rmin) x (SQRT ((n1 + n2) / 2)) = 9.5645

It can be seen that the shift in variation (ROT) for using a small nozzle is 9.5645. Since this figure is less than 10 it is evident that we can be confident that using a small nozzle size will not affect the KPO of the process.

**From Table 2.6**

Rmax =	0.41	n1 =	10
Rmin =	0.21	n2 =	10

Rmax x Rmax/Rmin x Rmin =	3.81179
(n1 + n2)/2 =	10
SQRT ((n1 + n2)/2) =	3.16228

Shift in variation = (Rmax x Rmax / Rmin x Rmin) x (SQRT ((n1 + n2) / 2)) = 12.0539

It is evident that using a standard nozzle does not influence the KPOV to such an extent as the ROT value of 12.0539 is also approximately 10. It can be predicted that



this experimental set up will influence the KPO of the process more than by using a small nozzle.

**From Table 2.7**

Rmax =	0.40	n1 =	10	Rmax x Rmax/Rmin x Rmin =	3.62812
Rmin =	0.21	n2 =	10	(n1 + n2)/2 =	10
				SQRT ((n1 + n2)/2) =	3.16228

$$\text{Shift in variation} = (R_{\max} \times R_{\max} / R_{\min} \times R_{\min}) \times (\text{SQRT} ((n_1 + n_2) / 2)) = 11.4731$$

Using a standard nozzle and higher stir speed, resulted in similar values as the previous experimental settings (value obtained 11.4731).

It can be concluded that a shift in variation of results (filling of tubes) by altering stirrer speed or nozzle size do not contribute to variation in the KPO of the process.

The filling operation is a complex process and by varying different input variables, the effect on the output variables of the process can be measured. Varying the stirrer speed and changing nozzle sizes all influence the KPOV of the filling operation in a different way. By using the data gathered, the process optimisation step (2.2.4) could be set up to investigate the interactions of the KPIV.

## **2.3. STEP 3: OPERATIONAL ANALYSES**

### **2.3.1. PROCESS OPTIMISATION**

Process optimisation involves the determination of those variables settings that best meet the overall objectives of the process. Firstly, optimum target values are determined to help maintain consistent process performance. Statistically based experimental techniques are used to establish optimum parameter values and to understand the nature of variation in the process.

Process optimisation focuses on minimising the variation in the process. To reduce variation, determination of all the process settings that can make the process robust, must be done. To determine the process settings that cause the process to be robust the relationship between KPIV and KPOV must be determined. When data of these interactions have been obtained, the process control limits can be optimised.

Process optimisation is thus achieved by driving out variation by means of controlling all variables in the process and by understanding how the key process input variables affect the key process output variables. A very important step in process optimisation involves making calculations that convert raw data into meaningful information. It also involves the interpretation of the experimental results using numerical or graphical methods. Analyses include the determination of the most important factors, selecting the optimal levels for those factors, understanding the nature and degree of variation in the process, and computing predicted values for the expected results at the recommended factor settings.

The final goal of process optimisation is to use the knowledge gained from the experiment to improve a process. Every product or service provided is the result of a combination or series of processes, whereby a variety of inputs come together to create one or more outputs. A process is therefore an added value transformation of input to output. Every process is subjected to variation. No process is absolutely predictable, but the performance of any reasonably reliable process can be predicted

within limits, provided nothing interferes arbitrarily with the process. The narrower the process variation is, the more predictable the process [19]. Results of the optimisation process may be used to develop more appropriate product and process limits, to modify how certain steps of the process are performed, or to choose the best materials and equipment. Any changes in the process itself will require changes to the documentation that supports the process. A new and improved process baseline may be established, which requires that process characterisation be completed for the new baseline. With a better understanding of the process variation, a positive control plan can be established to control the variation of all inputs to the process. After process optimisation, a more effective control program can be established for the operation.

For the purpose of the optimisation exercise, the following assumptions were made: Variations introduced into the process by the bulk active, containers, conditions and machine variations are constant and controlled. The experiment was conducted with 25 g tubes.

#### Actual Method:

From the previously used tool it became apparent that the key performance input variables (KPIV's) namely filling speed, stirrer speed and nozzle size all have an effect on the key process output variables (KPOV's).

In the first experiment the machine filling speed was adjusted relative to the machine stirrer speed while keeping the filling nozzle constant (standard nozzle) – see work instructions 2.3.1.1. (A) below. The results of the first experiment is shown in Table 2.11 and illustrated graphically in Graphs 2.7, 2.7.1, 2.8 and 2.8.1.

In the second experiment, the machine filling speed and nozzle size was adjusted while keeping the stirrer speed constant at 34 rpm. (see work instructions 2.3.1.1. (B)

below). Results obtained are presented in Table 2.12 and illustrated graphically illustrated in Graphs 2.9, 2.9.1, 2.10 and 2.10.1.

### **2.3.1.1. Procedure for Tonazzi Set up, Sampling and Testing for Variable Interactions in Filling Room**

(A) Variable Interactions of Machine Filling Speed vs. Stirrer Speed with standard nozzle:

1. Charge hopper of Tonazzi with cream/ointment to be tested (in this instance Skincalm® cream).
2. Set stirrer speed to 34 rpm. Use standard nozzle.
3. Set filling speed to 55 (Low setting).
4. Run machine and ensure all settings are correct for standard operation and machine is operating consistently.
5. Continue to run machine and collect filled tubes every 5 seconds, collect 9 filled tubes, label samples “1” to “9”. Collect all samples in a plastic bag labelled F55 -S34-StdN.
6. Increase filling speed to 70 (High setting).
7. Run machine for 30 seconds to stabilize outputs then collect filled tubes every 5 seconds, collect 9 samples, label samples “1” to “9”. Collect all samples and put into plastic bag labelled F70-S34-StdN.
8. Set stirrer speed to 39 rpm. Keep filling speed at 70 (High setting).
9. Run machine and ensure all settings are correct for standard operation and machine is operating consistently.
10. Continue to run machine and collect filled tubes every 5 seconds, collect 9 filled tubes, label samples “1” to “9”. Collect all samples in a plastic bag labelled F70-S39-StdN.
11. Decrease filling speed to 55 while stirrer speed is still set at 39 rpm.

12. Run machine for 30 seconds to stabilize outputs then collect filled tubes every 5 seconds, collect 9 samples, label samples "1" to "9". Collect all samples and put into plastic bag labelled F55-S39-StdN.
13. These samples are then weighed and results transferred to Sheet 1.
14. Plot/Calculate the results and determine variable interactions of filling speed vs. stirrer speed with standard nozzle.

Abbreviations: F55 - Machine-filling speed low at 55  
F70 - Machine filling speed high at 70  
S34 - Stirrer speed low at 34 rpm  
S39 - Stirrer speed high at 39 rpm  
StdN - Standard nozzle size

The low (-) and high (+) designations indicate low and high levels of an experimental variable and represent a coded value of the actual (natural) factor level. For calculation purposes, the variable settings in Table 2.11 and Table 2.12 are coded by using the formula:

$$x_1 = (x_i - x_o) / x_s$$

where  $x_1$  = coded value of variable  $x_i$ ;  $x_i$  = the actual variable setting;  $x_o$  = the midpoint value between the low and high settings of  $x_i$ ; and  $x_s$  = the step size from the midpoint value to the actual setting of  $x_i$  [23].

	Settings		
	Low	High	
Var A = Speed	55	70	Filling Speed set at 55 or 70 Stirrer speed at 34 or 39 Nozzle kept constant (STD nozzle)
	-1	1	
Var B = Stirrer	34	39	
	-1	1	

Run	Speed	Stirrer	Speed	Stirrer	Dot product	Weight per tube (grams)									Output Ave	Std dev	
						Output 1	Output 2	Output 3	Output 4	Output 5	Output 6	Output 7	Output 8	Output 9			
1	55	34	-1	-1	1	30.81	30.59	30.61	30.60	30.58	30.82	30.78	30.80	30.62	30.69	0.1078	
2	55	39	-1	1	-1	30.61	30.80	30.39	30.60	30.60	30.61	30.60	30.59	30.59	30.60	0.1028	
3	70	34	1	-1	-1	30.83	30.77	30.63	30.58	30.40	30.62	30.82	30.80	30.40	30.65	0.1693	
4	70	39	1	1	1	30.59	30.60	30.61	30.60	30.60	30.40	30.58	30.60	30.62	30.58	0.0676	
Ave.Ave @ High setting			30.61	30.59	30.63										Average:	30.63	0.1119
Ave.Ave @ Low setting			30.64	30.67	30.62												
High - Low			-0.031	-0.082	0.009												
Ave Std dev @ High setting			0.1185	0.0852	0.0877												
Ave Std dev @ Low setting			0.1053	0.1386	0.1361												
High - Low			0.0132	-0.0534	-0.0483												

**TABLE 2.11 VARIABLE INTERACTIONS OF FILLING SPEED AND STIRRER SPEED WITH CONSTANT NOZZLE**

The calculated values for the two main effects (Stirring speed and Filling speed), as well as the interaction between these two main effects, are given in Table 2.12

<b>Variable</b>	<b>Effect</b>	<b>Coefficient</b>	<b>Sum of Squares</b>	<b>% Contribution</b>
<b>Average</b>	30.63			
<b>Filling Speed</b>	-0.031	-0.017	0.01	15.25
<b>Stirrer Speed</b>	-0.082	-0.039	0.054	83.05
<b>Interaction</b>	0.009	0.00556	0.0011	1.69

**TABLE 2.13 CALCULATED EFFECTS**

The above results show that stirrer speed has the largest influence on the process outcome. It is also noted that the interaction between the filling and the stirrer speeds is very small and probably not statistically significant.

Table 2.14 below summarises the ANOVA results for an analysis performed on the data in Table 2. 11 with the assumption that the interaction between the two variables can be ignored. The assumption is made that that the observed results can be adequately explained by the model:

$$Y = \beta_0 + \beta_1 x_1 + \beta_2 x_2$$

where:

y = the response;

$\beta_0$  = the average;

$\beta_1$  = the coefficient for filling speed;

$\beta_2$  = the coefficient for stirring speed;

$x_1$  = the filling speed setting; and

$x_2$  = the stirring speed setting.

Source of Variation	Sum of Squares	Degrees of Freedom	Mean Squares	F-value	Prob>F
<b>Total</b>	0.49	35			
<b>Regression</b>	0.064	2	0.032	2.49	00987
<b>Residual</b>	0.43	33	0.013		
<b>Lack-of-fit</b>	0.0011	1	0.0011	0.083	0.7747
<b>Pure Error</b>	0.43	32	0.013		

**TABLE 2.14 ANOVA (IGNORING INTERACTION)**

The ANOVA results show that the model explains 90.13% of the variation in the results. Statistically this is somewhat lower than the desirable 95% commonly used in statistical modeling. However, the lack of fit value is very small, which means that the model is excellent in predicting results.

Graph 2.7 shows that the slope of the two lines in the graph is approximately parallel to each other, i.e. there is no interaction between stirring speed and filling speed on the average KPO (average weight of tubes) when varying the filling speed and stirrer speed while keeping the filling nozzle constant. When considering the filling speed and stirrer speed separately (Graph 2.7.1 figures B and C), it is evident that these two variables have a negative influence (negative slope) on the KPO average of the operation when they are increased from low to high settings.



**Design-Expert Plot**

**Actual Mass (g)**

**m**

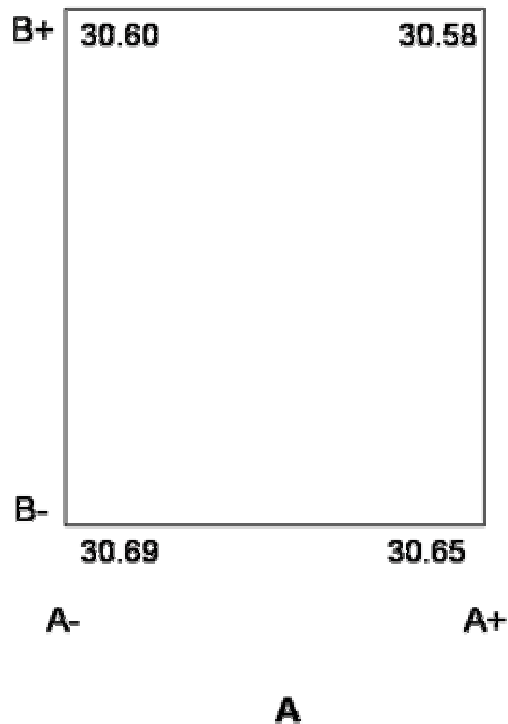

**FIGURE 2.10 SQUARE PLOT OF AVERAGE FOR VARIABLE FILLING SPEED AND STIRRER SPEED COMBINATIONS**

Figure 2.10 shows a square plot of the average for the four possible combinations of variable settings calculated from Table 2.11.

This plot shows that the most favourable KPO averages are obtained with the variable settings for stirrer and filling speed both set to their low values, and the least favourable KPO averages are obtained for stirrer and filling speed both set to their high values.

Graph 2.8 A shows that filling and stirrer speed have an interaction on the variance of the KPO. The least variance of the KPO occurred when the filling speed on the machine was set to 55 (low setting) with either setting of the stirrer speed. The optimal settings for the process lies were the two lines intersect in Graph 2.8. Filling speed (Graph 2.8.1 B) effects the variance of the process the most as a single factor (i.e. increase filling speed increase variance – positive slope).

By varying filling speed and nozzle size and keeping stirrer speed constant, gave similar results compared to varying filling speed and stirrer speed while keeping nozzle size constant.

A

## Interaction on average

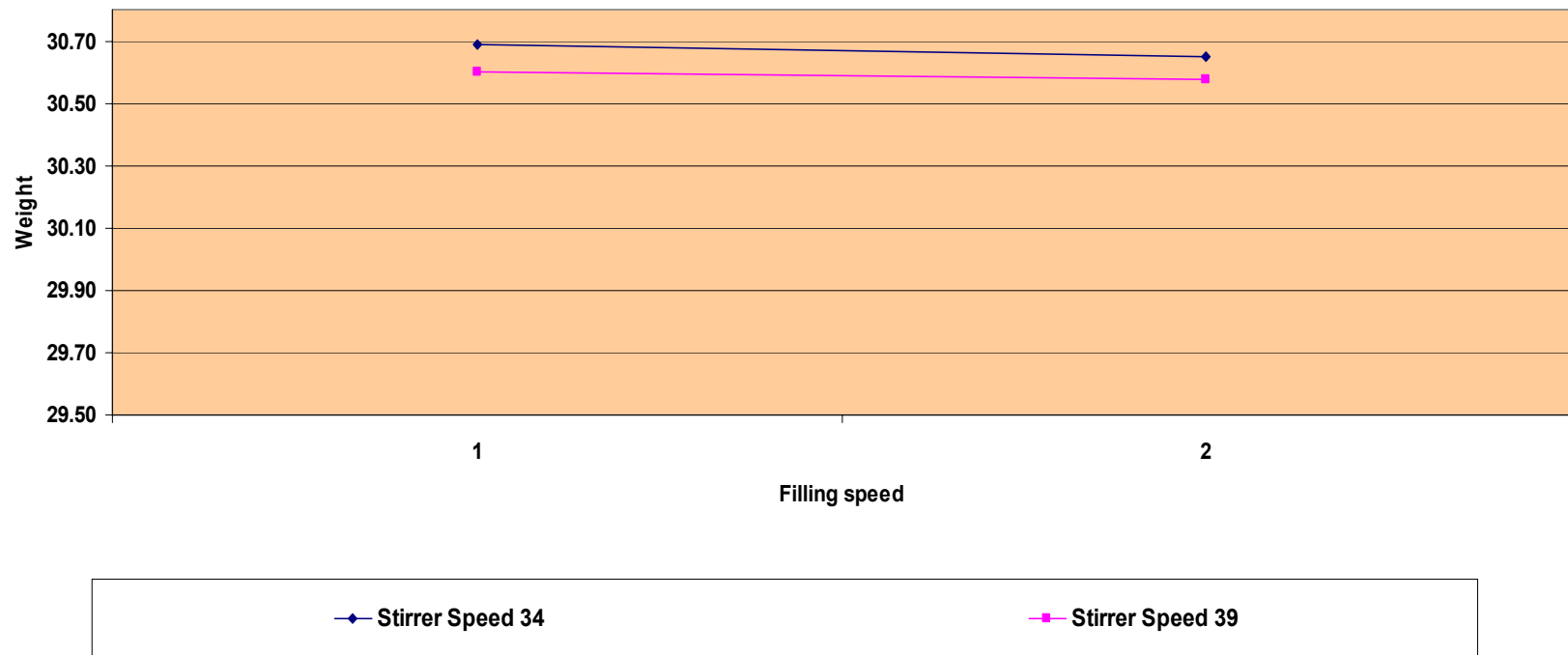

GRAPH 2.7 INTERACTIONS ON AVERAGE OF VARIATION IN FILLING AND STIRRER SPEED.

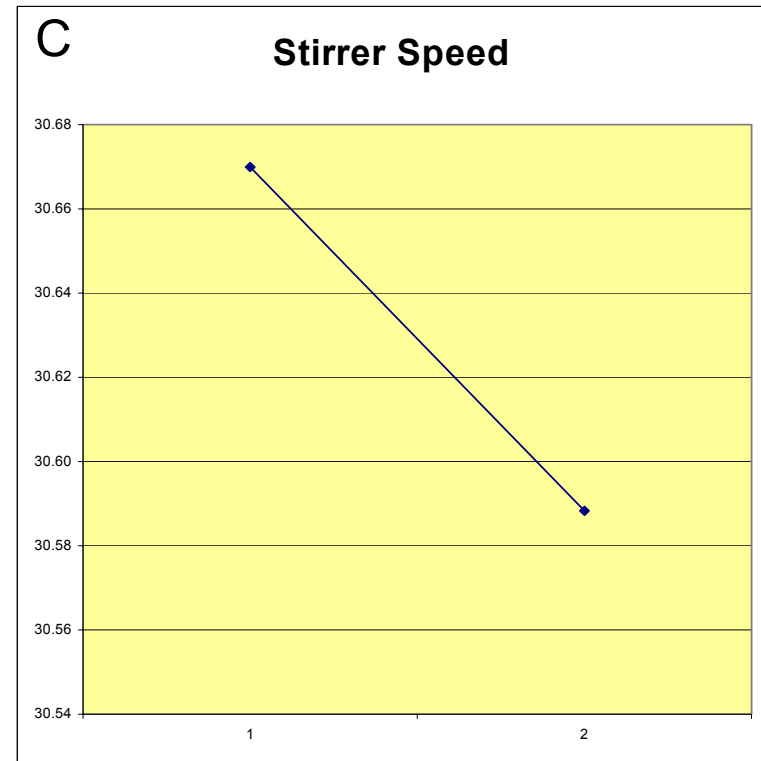
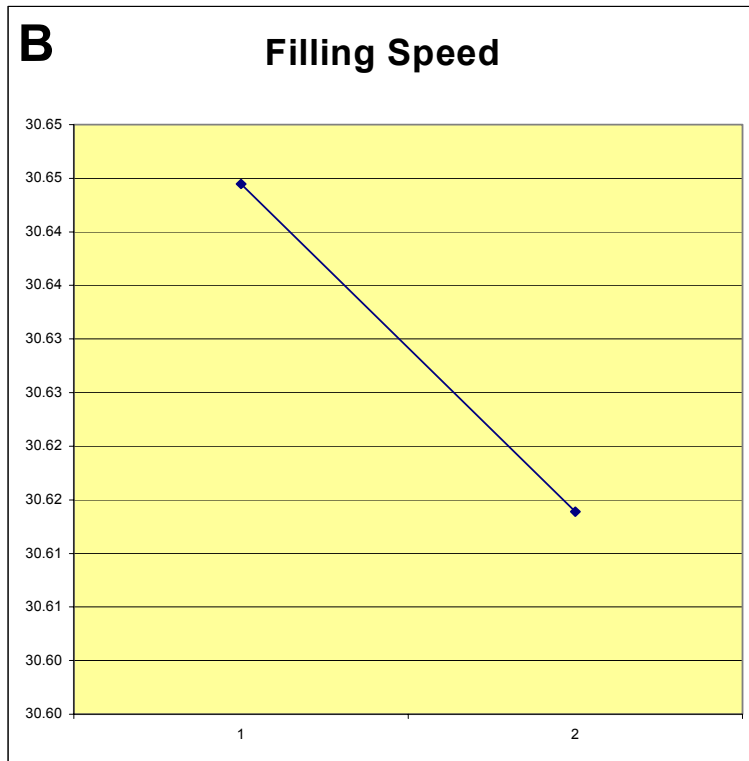

**GRAPH 2.7.1 INDIVIDUAL INTERACTIONS ON AVERAGE OF VARIATION IN FILLING AND STIRRER SPEED**

A

## Interaction on variance

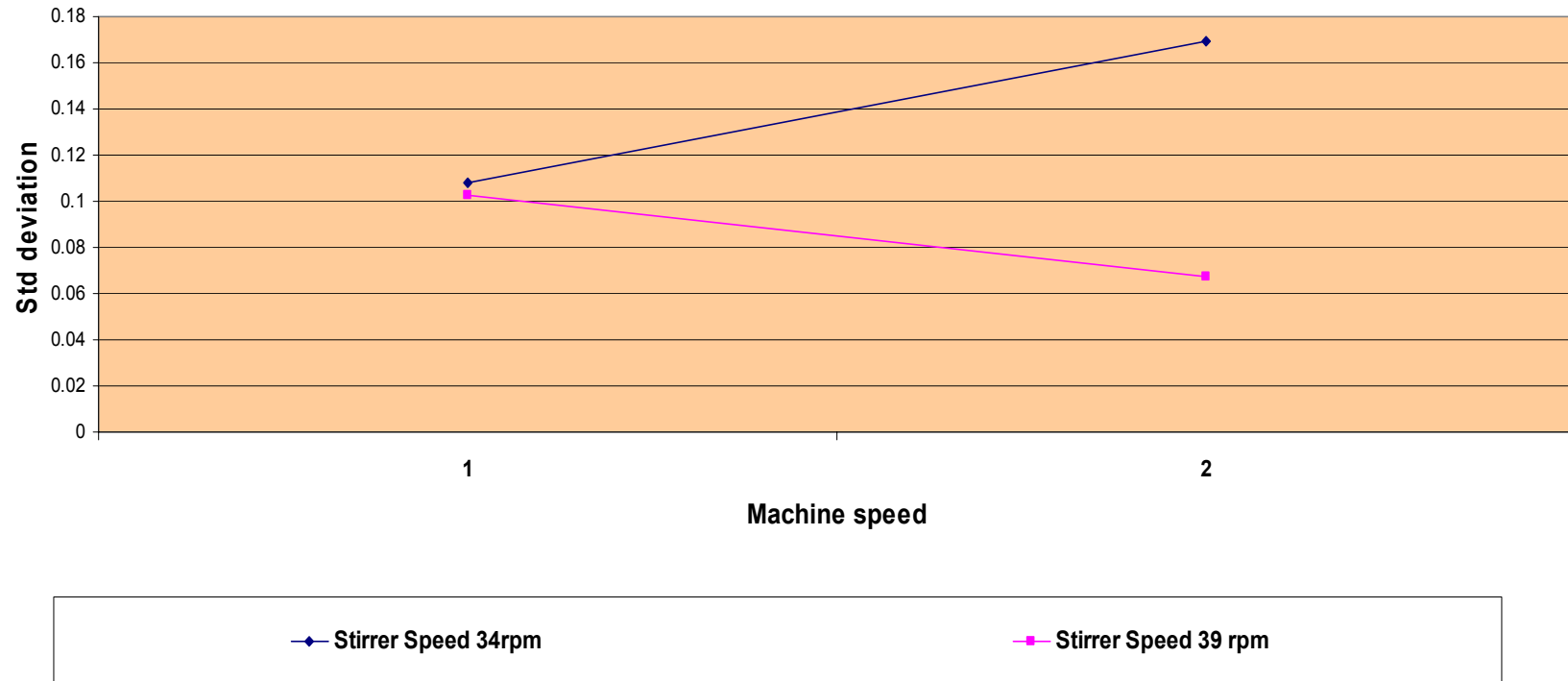

GRAPH 2.8 INTERACTIONS ON VARIANCE OF VARIATION IN FILLING AND STIRRER SPEED

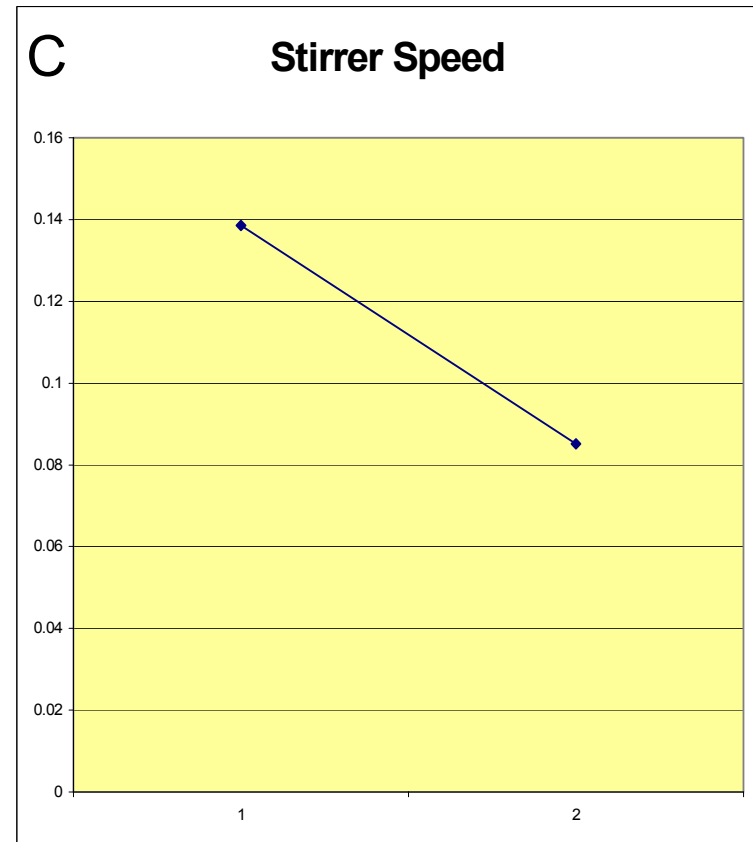
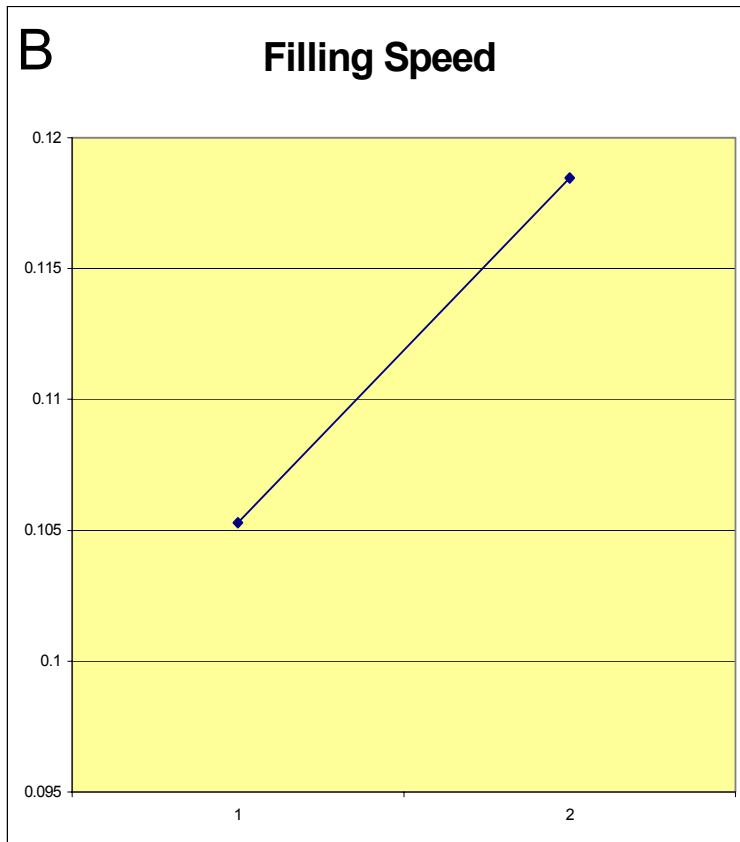

**GRAPH 2.8.1 INDIVIDUAL INTERACTIONS ON VARIANCE OF VARIATION IN FILLING AND STIRRER SPEED**

(B) Variable Interactions of Machine Filling Speed vs. Nozzle size with constant stirrer speed:

1. Charge hopper of Tonazzi with cream/ointment to be tested (in this instance Skincalm® cream).
2. Set stirrer speed to 34 rpm. Use small nozzle.
3. Set filling speed to 55 (Low setting).
4. Run machine and ensure all settings are correct for standard operation and machine is operating consistently.
5. Continue to run machine and collect filled tubes every 5 seconds, collect 9 filled tubes, label samples “1” to “9”. Collect all samples in a plastic bag labelled F55-S- S34.
6. Increase filling speed to 70 (High setting).
7. Run machine for 30 seconds to stabilize outputs then collect filled tubes every 5 seconds, collect 9 samples, label samples “1” to “9”. Collect all samples and put into plastic bag labelled F70-S-S34.
8. Change nozzle from small to standard nozzle. Keep stirrer speed the same at 34 rpm and the filling speed still at 70 (High setting).
9. Run machine and ensure all settings are correct for standard operation and machine is operating consistently.
10. Continue to run machine and collect filled tubes every 5 seconds, collect 9 filled tubes, label samples “1” to “9”. Collect all samples in a plastic bag labelled F70-Std-S34.
11. Decrease filling speed to 55 while standard nozzle is still attached and stirrer speed is still at 34 rpm.
12. Run machine for 30 seconds to stabilize outputs then collect filled tubes every 5 seconds, collect 9 samples, label samples “1” to “9”. Collect all samples and put into plastic bag labelled F55-Std-S34.
13. These samples are then weighed and results transferred to Sheet 2.
14. Plot/Calculate the results and determine variable interactions of filling speed vs. nozzle size with constant stirrer speed of 34 rpm.

15. Abbreviations: F55 - Machine-filling speed low at 55  
F70 - Machine filling speed high at 70  
Std - Standard nozzle  
S - Small nozzle  
S - Stirrer speed at 34 rpm



	Settings	
	Low	High
Var A = Speed	55	70
	-1	1
Var B = Nozzle	Small	STD
	-1	1

Filling Speed set at 55 or 70  
 Nozzle size at Small or Standard  
 Stirrer Speed kept constant at 34rpm

Run	Speed	Nozzle	Speed	Nozzle	Dot product	Weight of tubes (in grams)									Outpt Ave	Std dev	
						Output 1	Output 2	Output 3	Output 4	Output 5	Output 6	Output 7	Output 8	Output 9			
1	55	Small	-1	-1	1	29.98	30.09	29.80	30.17	30.09	29.88	29.98	30.00	30.04	30.00	0.1128	
2	55	STD	-1	1	-1	30.81	30.59	30.60	30.63	30.57	30.78	30.79	30.83	30.61	30.69	0.1087	
3	70	Small	1	-1	-1	29.88	29.89	30.03	29.83	29.63	28.77	29.80	29.79	29.80	29.71	0.3692	
4	70	STD	1	1	1	30.79	30.78	30.60	30.60	30.63	30.41	30.58	30.81	30.79	30.67	0.1357	
Ave.Ave @ High setting			30.19	30.68	30.33										Average:	30.27	0.1816
Ave.Ave @ Low setting			30.35	29.86	30.20												
High - Low			-0.157	0.819	0.133												

Ave Std dev @ High setting	0.2525	0.1222	0.1243
Ave Std dev @ Low setting	0.1108	0.2410	0.2390
High - Low	0.1417	-0.1188	-0.1147

**TABLE 2.12 VARIABLE INTERACTION OF FILLING SPEED AND NOZZLE SIZE WITH CONSTANT STIRRER SPEED**

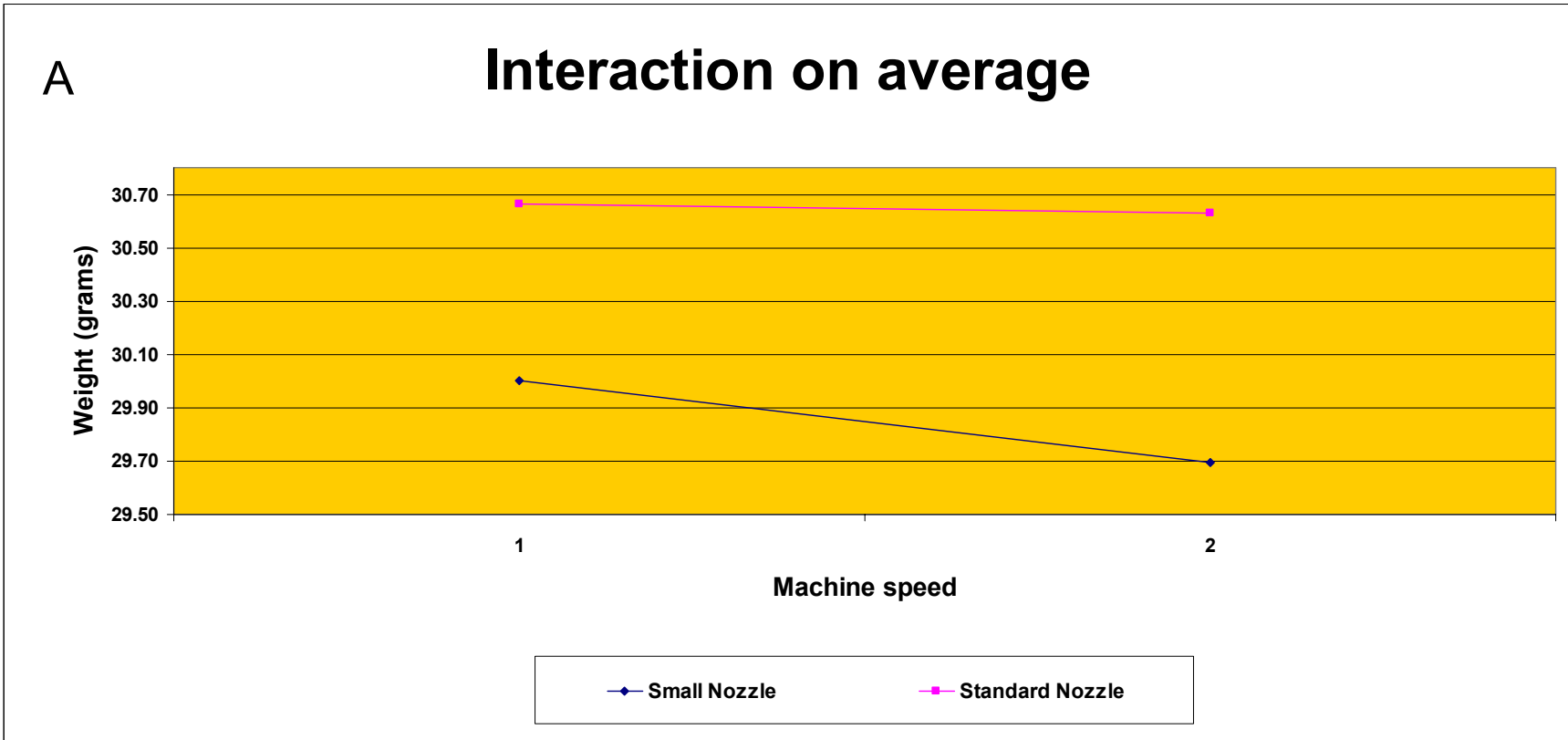

**GRAPH 2.9 INTERACTION ON AVERAGE OF VARIATION IN FILLING SPEED AND NOZZLE SIZE**

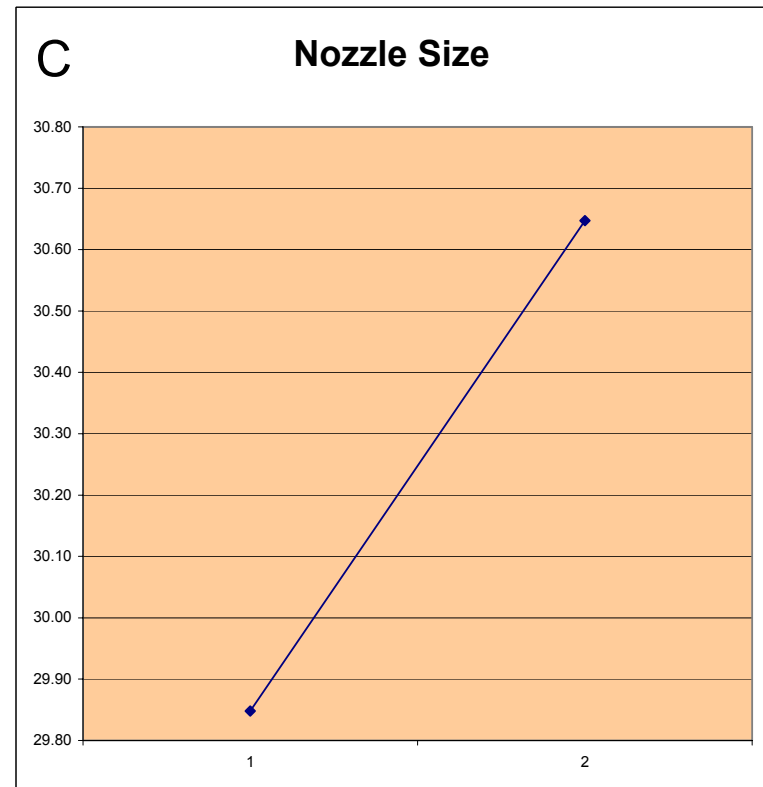
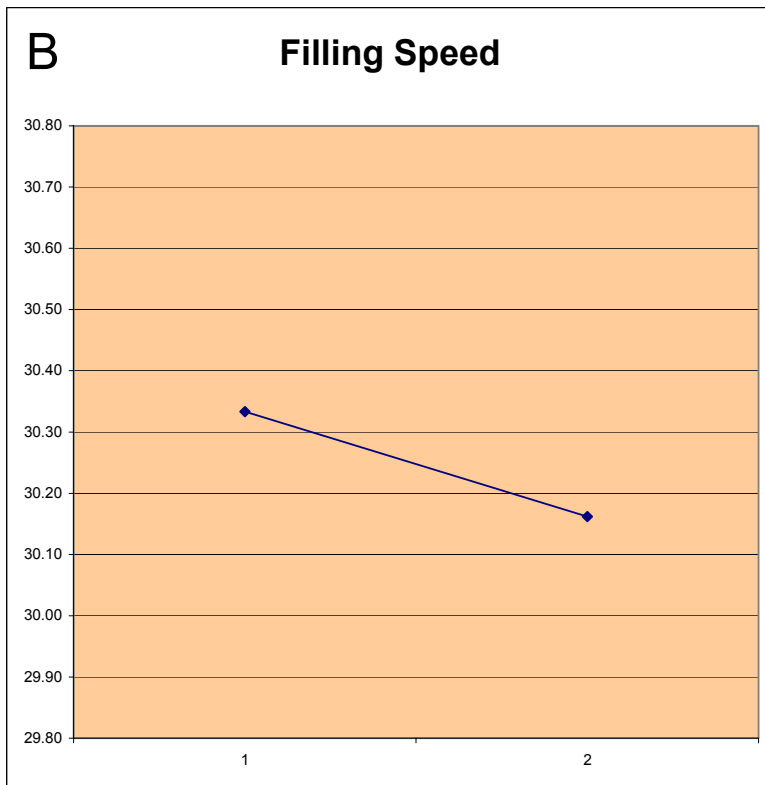

**GRAPH 2.9.1 INDIVIDUAL INTERACTION ON AVERAGE OF VARIATION IN FILLING SPEED AND NOZZLE SIZE**

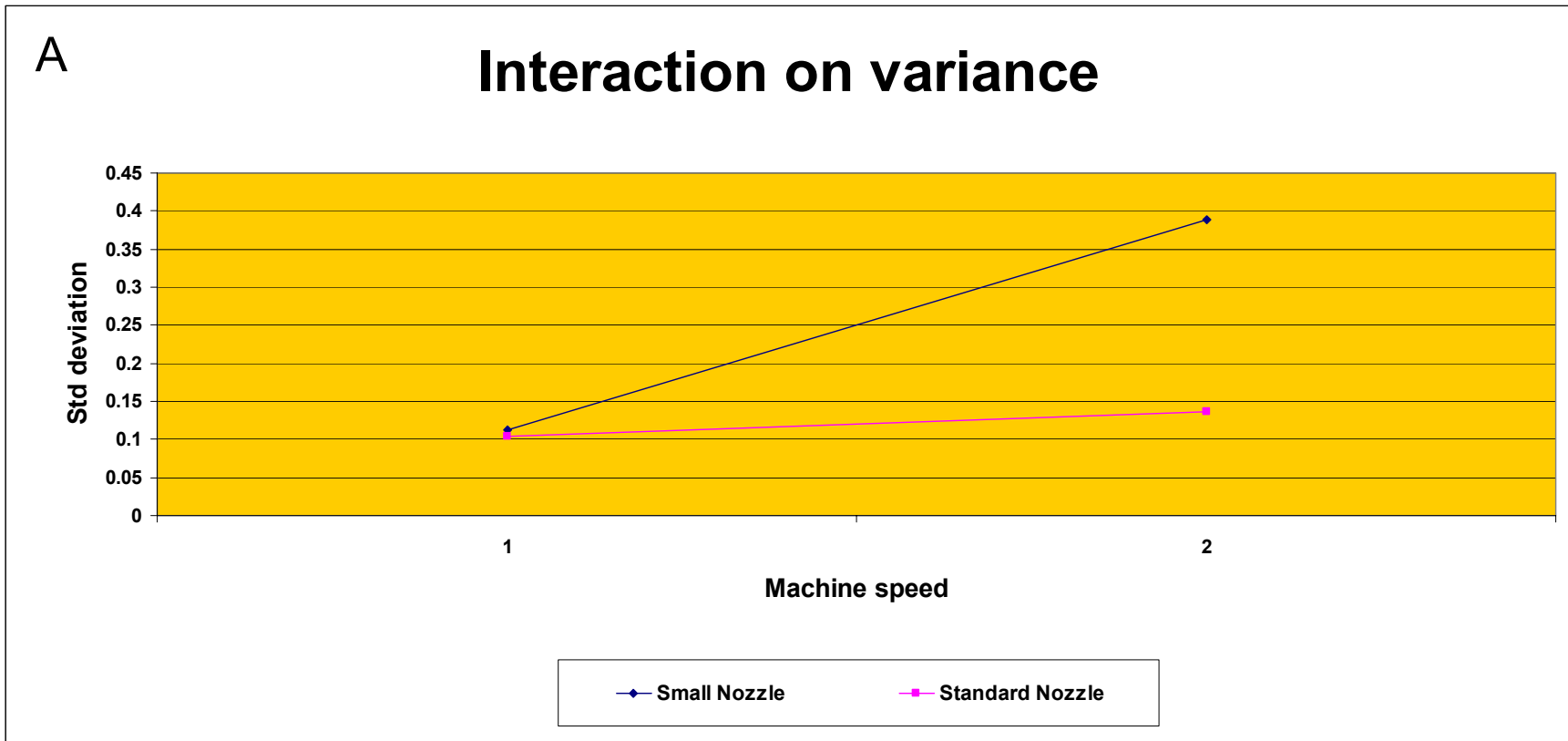

**GRAPH 2.10 INTERACTION ON VARIANCE OF VARIATION IN FILLING SPEED AND NOZZLE SIZE**

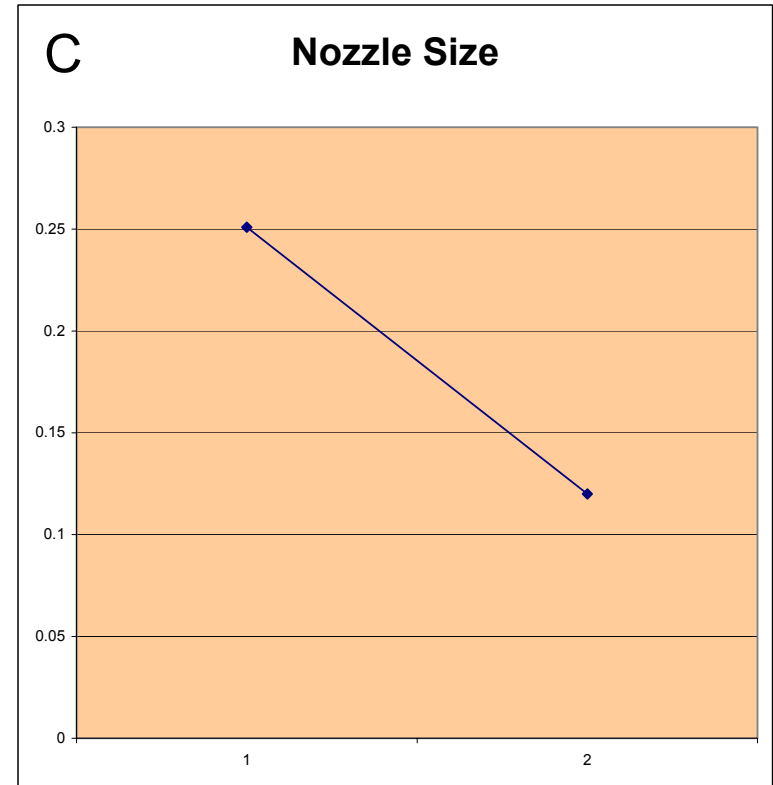
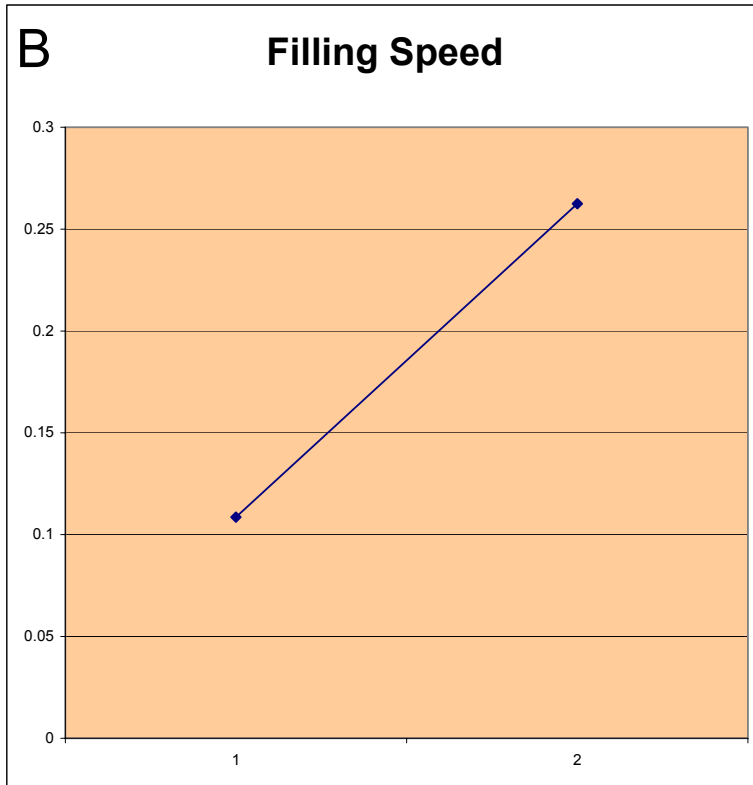

**GRAPH 2.10.1 INDIVIDUAL INTERACTION ON VARIANCE OF VARIATION IN FILLING SPEED AND NOZZLE SIZE**

The calculated values for the two main effects (nozzle size and filling speed), as well as the interaction between these two main effects, are given in Table 2.15

<b>Variable</b>	<b>Effect</b>	<b>Coefficient</b>	<b>Sum of Squares</b>	<b>% Contribution</b>
<b>Average</b>	30.27			
<b>Filling Speed</b>	-0.157	-0.072	0.19	2.72
<b>Stirrer Speed</b>	0.819	0.43	6.59	95.34
<b>Interaction</b>	0.133	0.061	0.13	1.95

**TABLE 2.15 CALCULATED EFFECTS**

The above results show that stirrer speed has the largest influence on the process outcome. Also, the interaction between the filling and the stirrer speeds is very small and probably not statistically significant.

Table 2.16 below summarises the ANOVA results for an analysis performed on the data in Table 2.12 and the assumption that interaction between the two variables can be ignored. This means that we assume that the observed results can be adequately explained by the model:

$$Y = \beta_0 + \beta_1 x_1 + \beta_2 x_2$$

where:

$y$  = the response;

$\beta_0$  = the average;

$\beta_1$  = the coefficient for filling speed;

$\beta_2$  = the coefficient for stirring speed;

$x_1$  = the filling speed setting; and

$x_2$  = the stirring speed setting.

Source of Variation	Sum of Squares	Degrees of Freedom	Mean Squares	F-value	Prob>F
<b>Total</b>	8.19	35			
<b>Regression</b>	6.78	2	3.39	79.04	<0.0001
<b>Residual</b>	1.41	33	0.043		
<b>Lack-of-fit</b>	0.13	1	0.13	3.36	0.0761
<b>Pure Error</b>	1.28	32	0.04		

**TABLE 2.16 ANOVA (IGNORING INTERACTION)**

The ANOVA results show that the model explains >99.99% of the variation in results, and also no lack of fit is evident.

Graph 2.9 shows that the two lines on the graph runs approximately parallel to each other which indicate that there is no significant interaction between varying machine speed and nozzle sizes on the KPO average. Filling speed again (Graph 2.9.1 B) has a negative effect on the KPO average (i.e. when increasing filling speed from a low setting to a high setting a decrease in weight of the filling tubes is observed). Nozzle size (Graph 2.9.1 C) increase the KPO average i.e. increasing from low to high setting leads to increase in KPO average.

**Design-Expert Plot**

**Actual Mass (g)**

**m**

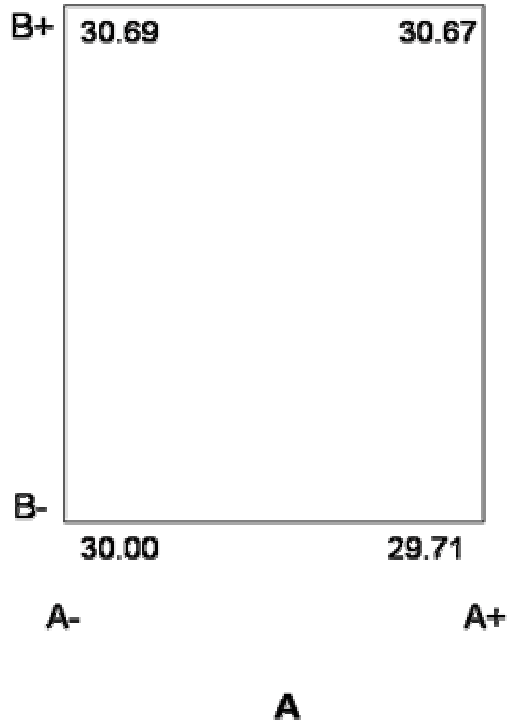

**FIGURE 2.11 SQUARE PLOT OF AVERAGE FOR VARIABLE FILLING SPEED AND NOZZLE SIZE COMBINATIONS**

Figure 2.11 shows a square plot of the average for the four possible combinations of variable settings calculated from Table 2.12.

The plot shows that the highest KPO averages are obtained with the filling speed set to its lowest value, while the stirrer speed is set to a high value. The lowest KPO averages were obtained for filling speed set to its high value, with the stirrer speed set to its low value.

The interaction of filling speed and nozzle size on the variance of the KPO is illustrated in Graph 2.10 A. The two lines for the different size nozzles intercept at the low setting of filling speed (namely 55 rpm). This indicates that by using either nozzle size, the KPO variance would be the least at the low setting of the filling speed. From the data obtained it can be concluded that the most robust setting for the filling operation will be using a machine filling speed of 55 and standard nozzle size.



## **CHAPTER 3**

### **CONCLUSION AND RECOMMENDATIONS**

A study was undertaken in the ointments and creams filling operation using some Six Sigma principles. The product focused on within the operation was Skincalm®.

The study came about due to problems experienced during the filling process and due to financial targets not meeting the budgeted figure in the ointments and creams filling process. Information was required about the process to investigate these problems.

The study used some simplified Six Sigma tools to gather data on the process. Operator knowledge and experience were used to build onto the data captured during the Six Sigma study.

The steps involved in the study were to define the key production steps within the ointments and creams filling operation (step 1). Once defined, data about the operation was collected (step 2). Data collected for Skincalm® was targeted for analysis and process improvement (step 3).

A critical path flow was established for the operation. Key input variables into the ointments and creams filling operation was identified namely material, equipment, people, procedures/methods and environment. Two key output metrics namely meeting standard time and product within specification was examined. Factors affecting these two output process metrics were gathered using the Cause and Effect diagram tool. Factors affecting standard time were highlighted using Pareto downtime graphs. From these graphs the major downtime categories namely machine, set up and filling were scrutinised and reduced by introducing tools namely graphically work instructions and 5S

principles. By focusing on meeting specification, an MSA tool for reducing variation due to equipment and people in the process was used by using a two decimal scale. The relationship between KPOV and KPIV with respect to machine filling speed, stirrer speed and filling nozzle size was studied using statistical experimentation. It was noticed that filling speed do statistically influence the KPO of the process, while stirrer speed and nozzle sizes do not contribute individually in the variation of KPO results of the process. Furthermore, it was established using statistically based experimental techniques that by filling 70 tubes per minute, using a standard nozzle and stirrer speed of 34 rpm will produce the best robust setting for the process.

#### Recommendations:

- use data and information obtained for future reference and new product designs for ointments and creams filling operation.
- display Cause and Effect diagrams in production area for easy reference and problem solving.
- continue to graphically illustrate all work instructions for the process. The work instructions can be used for training.
- continue and maintain 5S process. The 5S process is a discipline that must continue which will aid in exposing waste areas in the operation.
- update SOP with new robust settings for Skincalm® to optimise the process.

# BIBLIOGRAPHY

1. Big Enough To Care, Aspen Pharmacare Brochure, 2004.
2. Kiemele, M, Schmidt, S. and Berdine, R., Basic Statistics: Tools for Continuous Improvement, 4<sup>th</sup> edition, Air Academy Press, Colorado, 2000.
3. [www.ge.com/six sigma](http://www.ge.com/six sigma)
4. [www.iSixSigma.com](http://www.iSixSigma.com)
5. Eckes, G., Six Sigma for Everyone, John Wiley & Sons, New Jersey, 2003.
6. Mikel, H. and Schroeder, R., Six Sigma, The Breakthrough Management Strategy, New York, 2003.
7. Smith, D. and Blakeslee, J., Strategic Six Sigma, John Wiley & Sons, New Jersey, 2002.
8. Brue, G. and Launsby R., Design for Six Sigma, McCraw- Hill, New York, 2003.
9. Pyzdek, T., The Six Sigma handbook, Mc Graw-Hill, New York, 2001.
10. Gardiner, M. Introduction of Six Sigma to Greenbelts, Powerpoint Presentation at Aspen Phamacare, Port Elizabeth, November 2002.
11. Walden, J., Applying Six Sigma Methodology to Supply Chain Operations. Paper presented at SAPICS 24<sup>th</sup> Annual Conference and Exhibition Empowering the Supply Chain of Africa, Sun City, South Africa, 8-10 July 2002.
12. Harry M. The Nature of Six Sigma Quality. Motorola, Inc., Government Electronics Group, 1988.
13. Bhoté K., The power of Ultimate Six Sigma, Amacon, New York, 2003.
14. Barney, M. and McCarty, T., The New Six Sigma, Prentice Hall PTR, New York, 2003.
15. Rummler, M. and Brache, A., Improving Performance: How to Manage the White Spaces on the Organization Chart, Jossey - Bass, San Francisco, 1990.
16. [www.mindtools.com](http://www.mindtools.com)

17. De Kievit, M., Notes taken during SIX SIGMA Phase I and II Greenbelt training course, Port Elizabeth, December 2002 and March 2003.
18. TRACC ®, Competitive Capabilities International, Cape Town, 2000.
19. Freud, J., Modern Elementary Statistics, 7<sup>th</sup> edition, Prentice- Hall, Inc., New York, 1988.
20. Freedman, D., Pisani, R. and Purves, R., Statistics, W Norton and Company, New York, 1980.
21. SPC XL Application Software, Air Academy Associates, Colorado Springs, 1999.
22. Schmidt, S. and Launsby, R., Understanding Industrial Designed Experiments, 4<sup>th</sup> edition, Air Academy Press, Colorado Springs, 1998.
22. SPC KISS Version 2.0, Digital Computations, Inc., Albuquerque, NM, 1997.
23. Zeelie, B., Lecture note handout: Experimental Design Analysis for Scientists and Engineers, Port Elizabeth Technikon, Port Elizabeth, 2003.

# **PART B**

## **FINANCIAL REPORT ON STUDY**

**FINANCIAL RETURNS BY INTRODUCING SOME SIX SIGMA  
PRINCIPLES TO THE OINTMENTS AND CREAMS FILLING  
OPERATION**

**SUBMITTED BY:**

**JOHANNES MARX**

**DATE COMPLETED AND SUBMITTED: JANUARY 2005**

## **FINANCIAL EXECUTIVE SUMMARY**

A study was undertaken in the ointments and creams filling operation using some Six Sigma principles. The financial report describes the cost elements (metrics) focussed on and report on the return on investment for the project.

All the cost elements showed positive financial indicators. Costs of rework, material usage variance, overtime, holding, as well as heads above budget cost were reduced. First pass yield increased and the value adding time decreased for the ointments and creams filling process. Undertaking this study made a favourable return on investment. It is therefore recommended that sustaining the introduced Six Sigma principles in the process will be financially beneficial.

## A. INTRODUCTION

A study was undertaken in the ointments and creams filling operation using some Six Sigma principles. The study came about due to problems experienced during the filling process and due to financial targets not meeting the budgeted figure in the ointments and creams filling process. Information about the process was required to investigate and to solve these problems.

Ointments and creams are characterised by a product range of relatively low volumes, but of high variety. Since unit production costs are high, a flexible but complex scheduling system, able to anticipate changing capacity and demand to match customer needs is required. By meeting standard time and producing products within specification will improve lead times, improve supply capability, and realise a significant capacity improvement in utilisation, which in turn will reduce overhead costs. Data for a specific product (Skincalm® cream) was targeted for analysis and improvement due to the high customer demand for this product. It was expected that the study would provide the information needed to make informed decisions (production and financial) regarding the process.

Before the project was undertaken, clear financial values were calculated to have a baseline to work from. Specific financial goals (metrics) were set out to be reached at the end of this process.

The study used some simplified Six Sigma tools to gather data on the process. Operator knowledge and experience were used to build onto the data captured during the Six Sigma study. Six Sigma focuses on reducing variation and achieving a uniform process resulting in less waste, less throughput time and less inventory.

The steps involved in the study were to define the key production steps within the ointments and creams filling operation (step 1). Once defined, data about the



operation was collected (step 2). Data collected for Skincalm® was targeted for analysis and process improvement (step 3).

A critical path flow was established for the operation. Key input variables into the ointments and creams filling operation were identified namely material, equipment, people, procedures/methods and environment. Two key output metrics namely meeting standard time and product within specification were examined. Factors affecting these two output process metrics were gathered using the Cause and Effect diagram tool. Factors affecting standard time were highlighted using Pareto graphs. From the graphs the major downtime categories, namely machine, set up and filling were scrutinised and reduced by introducing tools such as graphic work instructions and 5S principles. By focusing on meeting specification, a Measurement System Analysis tool for reducing variation due to equipment and people in the process was used by using a two decimal scale. The relationship between key performance output variables (KPOV) and key performance input variables (KPIV) with respect to machine filling speed, stirrer speed and filling nozzle size was studied using statistical experimentation. It was observed that filling speed statistically influence the KPO of the process, while stirrer speed and nozzle sizes do not contribute individually in variation of KPO results of the process. Furthermore, it was established using statistically based experimental techniques that by filling 70 tubes per minute, using a standard nozzle and stirrer speed of 34 rpm will produce the best robust setting for the process.

This financial report discusses the cost elements selected for this study.

## **B. COST ELEMENTS (METRICS)**

A metric is an objective indicator or measure that facilitates process improvement. Financial metrics were assigned at the onset of the project and were monitored throughout the project.

Figure B.1 shows the Macro Value Stream for Aspen Pharmacare. All the production departments involved (both value addition and non-value addition) in the total production process can be observed from Figure B.1. Value addition can be defined as those services or product processing that customers are willing to pay for. The project was focused on the ointments and creams filling operation, which form part of the liquid packing floor, indicated in Figure B.1. As can be seen from Figure B.1, the total metrics of the liquid packing floor is broken down into four metrics, namely, value adding time (VA), first pass yield (FPY), the average time a product stay in the department (Time) and the cost of doing nothing (CODN). From Figure B.1 the metrics for the liquid packing floor is given as VA of 27 hours, FPY as 96%, Time as 14 days and CODN as R10.52 million.

# SIX SIGMA MACRO VALUE STREAM

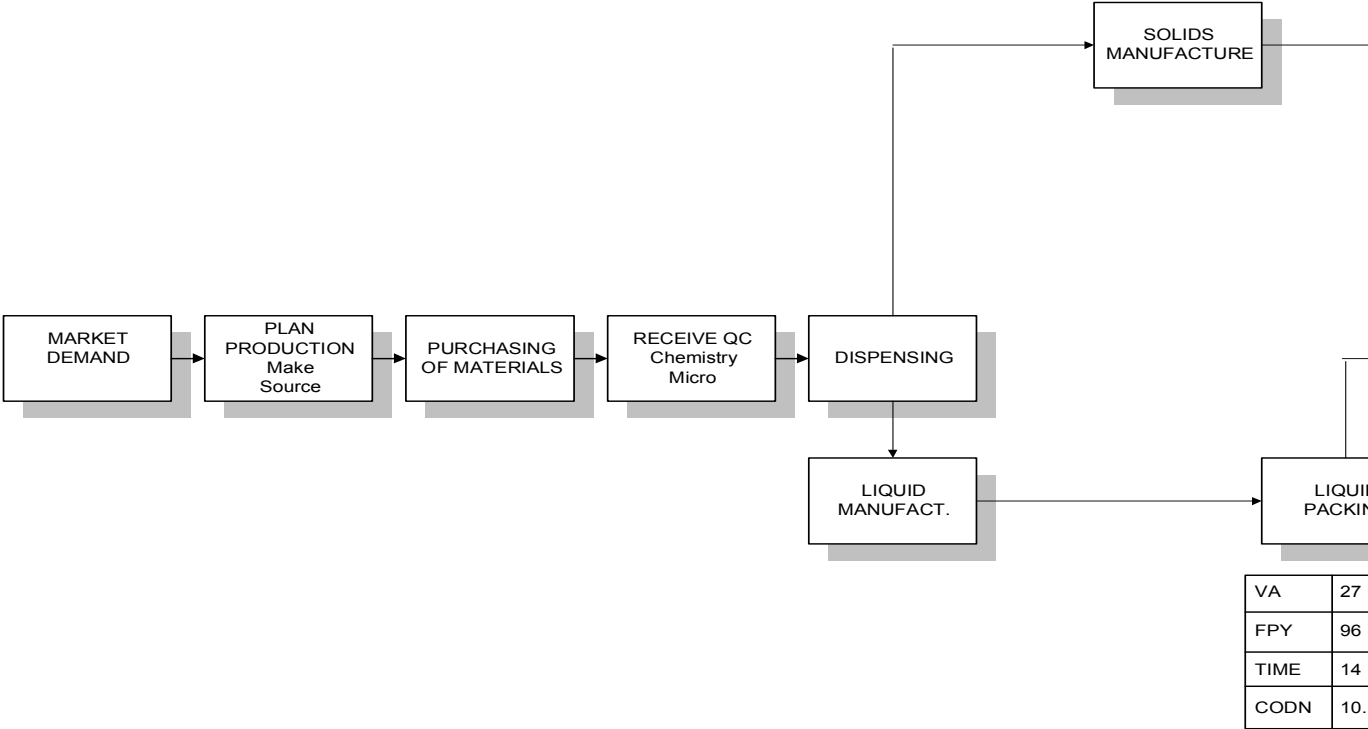

**FIGURE B.1 PRODUCTION VALUE STREAM FOR ASPEN PHARMACARE SHOWING FINANCIAL METRICS FOR LIQUID PACKING FLOOR**

The ointments and cream filling process contributes approximately 27% to the total CODN metrics for the Liquid packing floor. The CODN for the ointments and creams filling operation was R2 810 000.00. For this project, the financial focus was on this CODN.

CODN can be defined as:

$CODN = \text{Cost of Poor Quality (COPQ)} + \text{Lost Opportunity}$

CODN is the additional cost above that which is necessary to produce a product or a service. It is current process waste in terms of:

- ❖ lost capacity.
- ❖ raw material.
- ❖ utilities.
- ❖ resources.
- ❖ downtime.
- ❖ lost market.
- ❖ sales.

COPQ is anything that a customer does not knowingly want to pay for. The COPQ is the costs, which are generated as a result of producing defective products. This cost includes the cost involved in fulfilling the gap between the desired and actual product/service quality. The COPQ also includes the cost of lost opportunity due to the loss of resources used in rectifying the defect. This cost include the labour cost, rework cost and material cost that have been added to the product up to the point of rejection. COPQ does not include detection and prevention cost. COPQ should contain the material and labour costs of producing and repairing defective goods. The CODN is, therefore, the cost that is paid, knowingly or unknowingly, on an annual basis (12 month period).

Table B.1 shows the metric values that make up the CODN in the ointments and creams filling operation namely FPY, VA, rework costs, material usage variance, overtime, holding cost and heads above budget.

To be a VA action, the action must meet three of the following criteria, namely that the customer is willing to pay for this activity, it must be done right the first time and the action must somehow change the product or service in some manner. FPY is simply the number of acceptable units produced divided by the number of total units going into the process, expressed as a percentage. The FPY is a tool for measuring the amount of rework in a given process. FPY is thus a quality metric cost for the process. As can be seen from Table B.1, the starting FPY metric for the process was 92%, which equate to the actual rework cost for the process of R537 028.26. The starting metric value for process value adding time was 15 hours, and the material usage variance (cost of material used over the budgeted cost or variance of material that deviated from the process target) was R369 055.38. The combined total cost on overtime for wages and salaried staff was projected at R73 442.04 and the extra heads above the budgeted value was projected at R1.192 million. Holding cost (cost of holding the inventory in the department) was R99 486.27.

<b>Project Metrics</b>		
<b>Metric</b>	<b>Starting Metric 12 Month Projection</b>	<b>Target Metric 12 Month Projection</b>
First Pass Yield	92%	99%
Value Adding Time	15 hours	12 hours
Rework Costs	R537 028.26	R250 000.00
Material Usage Variance	R369 055.38	R185 000.00
Overtime Wages & Salaries	R73 442.04	R42 841.19
Holding Costs	R99 486.27	R42 841.19
Heads above Budget - wages only	R1 192 347.54	R695 536.65

**TABLE B.1 PROJECT STARTING AND TARGET METRICS**

## C. FINDINGS

The study focussed on reducing the CODN element by focusing on meeting standard time and producing ointments and creams within specification. By focusing on these two elements, the metrics as explained in the previous section (section B) would be affected. As can be seen from Table C.1, all the metrics had been given a target 12 month projected figure. The champion of the improvement project calculated this target figure and formed the targeted financial saving.

<b>Project Metrics</b>		
<b>Metric</b>	<b>Starting Metric 12 Month Projection</b>	<b>Current Metric 12 Month Projection (combined 12 months actual )</b>
First Pass Yield	92%	95%
Value Adding Time	15 hours	14 hours
Rework Costs	R537 028.26	R497 068.30
Material Usage Variance	R369 055.38	R170 899.80
Overtime Wages & Salaries	R73 442.04	R28 111.48
Holding Costs	R99 486.27	R77 806.80
Heads above Budget - wages only	R1 192 347.54	R823 217.59

**TABLE C.1 PROJECT STARTING AND CURRENT METRICS**

Over the projected period (Table C.1), the FPY increased with 3% to 95%. The increase of 3% meant that total rejects for the process was reduced by 3% over the project time.

VA came down by one hour. This reduction in VA time meant that waste was reduced in the process.

From Table C.1 it can also be seen that rework cost came down from the start of the project from R537 028.26 to R497 068.30. Material usage variance decreased over the period by R198 155.58, overtime and wages/salaries reduced to R28 111.48, holding cost decreased by R56 645.08 and heads above budget (wages only) was R823 217.59.

## Ointments and creams - ROI

Target ROI = R495 thousand

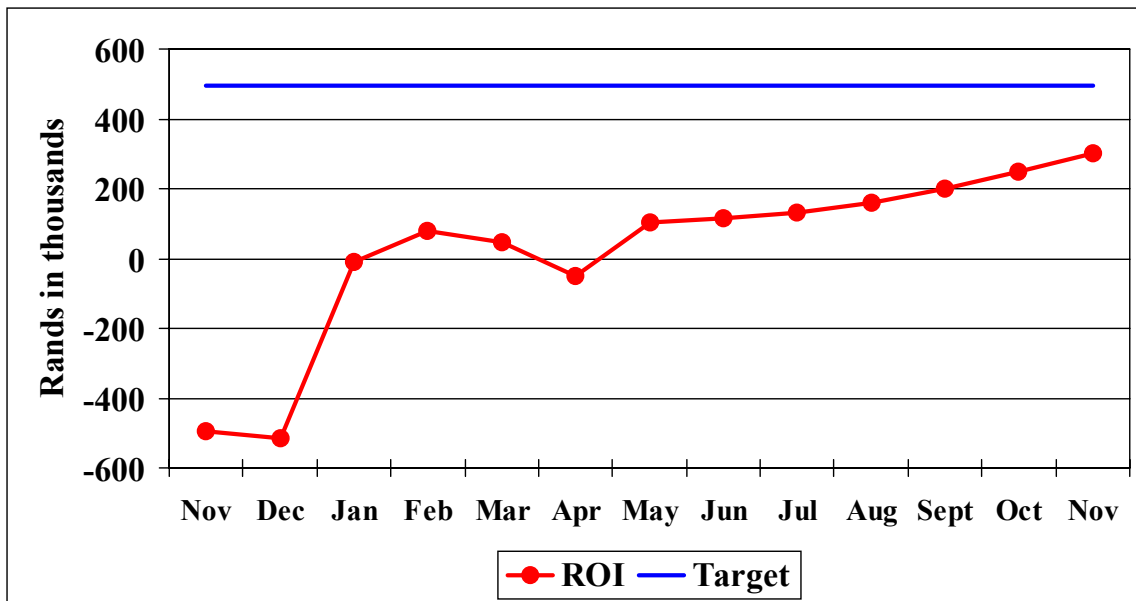

**GRAPH C.1 RETURN ON INVESTMENT (ROI) FOR 12 MONTH PERIOD**

From Graph C.1 it can be noted that the original ROI (return on investment) for the project was targeted at R495 000.00 starting at November for the given project period. The ROI refers to the amount of savings or profit a project can realise from any given use of money over a given period (for this project the



period was set out to be 12 months). The ROI figure took into consideration the resource of people, money and time taken to implement the project. From Graph C.1 it is also noted that the ROI steadily increased (red line) towards the targeted measure (blue line) of R495 000.00.

## D. DISCUSSION

From Table D.1 it can be seen that all the current metrics for the project have shown a positive increase. By focussing on meeting standard time FPY was improved to 95%, VA to 14 hours and holding costs reduced to R77 806.80.

Rework costs (R497 068.30), material usage variance (R170 899.80), overtime (R28 111.48) and heads above budget (R 823 217.59) all reduced by focusing on the KPO of meeting product specifications.

<b>Project Metrics</b>		
<b>Metric</b>	<b>Target Metric 12 Month Projection</b>	<b>Current Metric 12 Month Projection (combined 12 months actual )</b>
First Pass Yield	99%	95%
Value Adding Time	12 hours	14 hours
Rework Costs	R250 000.00	R497 068.30
Material Usage Variance	R185 000.00	R170 899.80
Overtime Wages & Salaries	R42 841.19	R28 111.48
Holding Costs	R42 841.19	R77 806.80
Heads above Budget - wages only	R695 536.65	R823 217.59

**TABLE D.1 PROJECT STARTING AND CURRENT METRICS**

From Table D.1 it is noted that the current 12 month metric for material usage has exceeded the targeted metric figure. This indicates that the material used for reworks have used less material than expected. This can be attributed to the fact that the actual ointment and cream bulk was re-filled and the cost was only incurred for the actual packing materials that include the labels and empty tubes.

The other financial metrics that show improved financial figures over and above the targeted figures that can be seen from Table D.1 is overtime and heads above budget. These metrics indicate that the entire operation in the ointments and creams produced product within specification and standard time, which in turn reduced the amount needed to work overtime and getting more people to produce the required output of the process.

Faulty tubes, resulting in cream leaking from the filled tubes, caused the high value of holding costs and rework costs. During the time of this study, a large amount of filled tubes were returned to the department for reworking which increased the holding cost and necessitated the use of extra people (heads above budget) to aid in the rework of the tubes.

From Graph C.1 it is noted that the ROI shows an increase towards the target of R495 000.00. The current ROI stands at R301 000.00. It can be seen from Graph C.1 that during the month of April the ROI actually decreased due to the fact that a large consignment of filled packs were returned to the process due to quality problems experienced in the market place. These quality problems were due to incorrect storage conditions. For the first two months of this study (November and December) the ROI dropped because the team involved in the Six Sigma process learned and gathered data before any changes to the process were made. A substantial increase in ROI occurred during the month of January when the team started implementing some changes. The ROI increased during the period which indicates that the time and money invested in the study paid dividends.

## **E. CONCLUSION**

Based on the financial analyses presented, it is recommended that Six Sigma continues in the ointment and creams filling operation. The Six Sigma initiatives implemented and introduced thus far need to be continued to ensure that the process stability and gains are sustained into the future. These Six Sigma principles can be maintained by continuation of daily and weekly checks to monitor the continuous process. The process metrics need to form part of the process owner's monthly performance indicators to ensure that the project and all actions are sustained. The champion of the project should be responsible for sustaining and improving the financial gains.

In order to maximise further returns from the implemented changes to the process it is recommended that staff and resources be committed to these changes.